

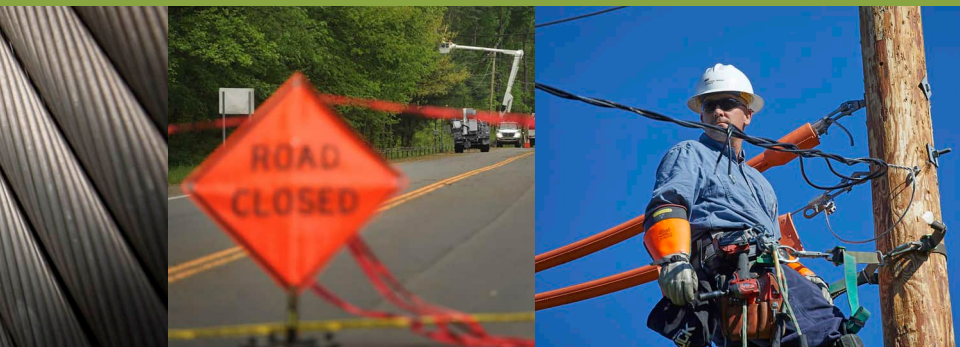

**CENTRAL MAINE
POWER**

An AVANGRID Company

Handbook of Requirements for Electric Service and Meter Installations



HANDBOOK
of
REQUIREMENTS
for
**ELECTRIC SERVICE AND
METER INSTALLATIONS**



Effective June 30, 2022



June 30, 2022

Dear Handbook Users,

I am pleased to announce a revised Handbook of Requirements. The Handbook is available electronically at:

www.cmpco.com/w/handbook

This year, we asked employees, contractors, and engineers to tell us how we could improve this book. Many offered great suggestions, comments, and insights.

As a result, several improvements have been made that will save both time and money while still offering customers safe and reliable electric service.

I want you to know we always welcome your comments and suggestions. Working together, we can do a better job meeting the needs of customers.

Yours Sincerely,

A handwritten signature in black ink that reads "Joe Purington". The signature is fluid and cursive, with a long horizontal stroke at the end.

Joe Purington
Central Maine Power
Chief Executive Officer

PREFACE

This handbook is effective June 30, 2022 and is a revision of an earlier edition dated January 1, 2009. Major changes are indicated by marginal lines. Minor editorial changes in certain cases are not indicated. As you read this handbook, you will see the words “company” and “we” used many times referring to “Central Maine Power Company.” All earlier editions of, and supplements to, this handbook are superseded and should be destroyed.

You may view this handbook on line at cmpco.com/handbook then click on CMP’s Handbook of Requirements link. Use the “Bookmarks” tab to get to specific sections.

TERRITORY SERVED

Central Maine Power company provides electric service to 350 cities and towns in Maine. The counties served include: Androscoggin, Cumberland, Franklin, Hancock, Kennebec, Knox, Lincoln, Oxford, Penobscot, Piscataquis, Sagadahoc, Somerset, Waldo, and York.

Our general offices are located at:

83 EDISON DRIVE
AUGUSTA, MAINE 04336
TEL 207.623.3521

Documents and payments should be mailed/emailed to address noted on requesting document.

To contact us for information or assistance, please use these toll-free phone numbers:

To request service or conduct other business

800.750.4000 (for RESIDENTIAL) or
800.565.3181 (for COMMERCIAL & INDUSTRIAL)

To report a power outage or other electrical trouble:

800.696.1000

DIG SAFE LAW

Maine’s Dig Safe law establishes requirements that excavators and others must follow when using power tools or equipment to penetrate the ground. For a copy of the rule, call the MPUC at 207.287.3831, or maine.gov/mpuc/

Before digging, notify DIG SAFE at: digsafe.com/ or 811

OVERHEAD HIGH-VOLTAGE LINE SAFETY NOTICE

In accordance with Maine Law (Title 35A M.R.S.A., Chapter 7A) a person may not erect, construct, operate, maintain, transport or store any equipment or item within 10-feet of an overhead high-voltage line (except as allowed for in the Law). When it is necessary to carry on any work or activity near an overhead high-voltage line, the person responsible for the work or activity must notify CMP by calling 800.696.1000 at least three (3) business days in advance (except in emergency situations). After mutually acceptable arrangements are negotiated, CMP will make the necessary precautionary safety arrangements.

OSHA under regulation 1926.1408 further limits equipment clearance to high voltage power lines to 20-feet unless specific criteria are met.

NESC (National Electric Safety Code) Section 23 further defines equipment vertical and horizontal clearance when installed by a qualified (as defined by OSHA) individual.

Primary voltage cutouts or disconnecting switches, installed by customers for their own use on privately owned systems, must be operated by a qualified (as defined by OSHA) individual.

CENTRAL MAINE POWER SERVICE CENTER

The following is a private toll-free number for contractors and electricians to use to coordinate service installations.

866.225.4200
or e-mail: gettingconnected@cmpco.com

Service Center Addresses:

Alfred
438 Sanford Rd
Alfred, ME 04002

Brunswick
280 Bath Road
Brunswick, ME 04011

Fairfield (Including Augusta)
205 Center Road
Fairfield, ME 04937

Farmington (Including Skowhegan and Dover)
209 Whittier Road
Farmington, ME 04938

Lewiston (including Bridgton)
740 Main Street
Lewiston, ME 04240

Portland
162 Canco Road
Portland, ME 04103

Rockland (Including Belfast)
24 Gordon Drive
Rockland, ME 04841

The Towns Within Our Territory

Abbot	Brunswick	Dixmont	Harpswell
Acton	Buckfield	Dover Foxcroft	Harrison
Adamstown	Buckspport	Dresden	Hartford
Albany	Burnham	Durham	Hartland
Albion	Buxton	East Moxie	Hebron
Alder Stream Township	Byron	Edgecomb	Hermon
Alfred	Cambridge	Eliot	Highland Plt
Alna	Camden	Elliotsville	Hiram
Andover	Canaan	Ellsworth	Hollis
Andover North Surplus	Canton	Embden	Hope
Anson	Cape Elizabeth	Etna	Hope Island
Appleton	Caratunk	Eustis	Industry
Arrowsic	Carmel	Exeter	Islesboro
Arundel	Carrabassett Valley	Fairfield	Jackman
Athens	Carthage	Falmouth	Jackson
Attean	Casco	Farmingdale	Jay
Auburn	Castine	Farmington	Jefferson
Augusta	Chain Of Ponds Township	Fayette	Jim Pond
Avon	Chase Stream Tract	Frankfort	Johnson Mt
Baldwin	Chebeague Island	Freedom	Kenduskeag
Bath	Chelsea	Freeman	Kennebunk
Beaver Cove Plt	Chesterville	Freeport	Kennebunkport
Belfast	China	Frenchtown	Kineo
Belgrade	Cliff Island	Friendship	Kingfield
Belmont	Clinton	Frye Island	Kingsbury Plt
Benton	Coburn Gore	Fryeburg	Kittery
Berwick	Concord	Gardiner	Knox
Bethel	Coplin Plt	Garland	Lang
Biddeford	Corinna	Georgetown	Lebanon
Big Moose Township	Corinth	Gilead	Leeds
Bingham	Cornish	Glenburn	Levant
Blanchard	Cornville	Gorham	Lewiston
Boothbay	Cumberland	Grafton	Lexington
Boothbay Harbor	Cushing	Gray	Liberty
Bowdoin	Cushing Island	Great Diamond Island	Lily Bay
Bowdoinham	Dallas Plt	Greene	Limerick
Bower Bank	Damariscotta	Greenville	Limington
Bremen	Davis	Greenwood	Lincoln Plt
Bridgton	Dayton	Guilford	Lincolnton
Brighton Plt	Denmark	Hallowell	Lisbon
Bristol	Dennistown	Hampden	Litchfield
Brooks	Detroit	Hanover	Little Diamond Island
Brownfield	Dexter	Harford's Point	Livermore
	Dixfield	Harmony	Livermore Falls

The Towns Within Our Territory

Long Island	Orland	Saint Albans	Troy
Long Pond	Otisfield	Saint George	Turner
Lovell	Owls Head	Salem	Union
Lower Cupsuptic	Oxford	Sandbar Tract	Unity
Lyman	Palermo	Sandy River Plt	Unity Twp
Madison	Palmyra	Sanford	Upton
Madrid	Paris	Sangerville	Vassalboro
Magalloway Plt	Parkman	Sapling	Verona
Manchester	Parlin Pond	Scarborough	Vienna
Mason	Parsonsfield	Searsmont	Waldo
Mechanic Falls	Peaks Island	Searsport	Waldoboro
Mercer	Penobscot	Sebago	Wales
Mexico	Perkins Plt	Sebec	Warren
Milton	Peru	Shapleigh	Washington
Minot	Phillips	Shirley	Washington Plt
Monmouth	Phippsburg	Sidney	Waterboro
Monroe	Pittsfield	Skowhegan	Waterford
Monson	Pittston	Smithfield	Waterville
Montville	Pleasant Ridge Plantation	Solon	Wayne
Moose River	Moose River	Somerville Plantation	Weld
Moosehead Junction Township	Plymouth	South Berwick	Wellington
Morrill	Poland	South Bristol	Wells
Moscow	Porter	South Portland	West Bath
Mount Vernon	Portland	South Thomaston	West Forks
Moxie Gore	Pownal	Southport	West Gardiner
Naples	Prospect	Squirrel Isle	West Paris
New Gloucester	Randolph	Starkish	Westbrook
New Portland	Rangeley	Starks	Westport
New Sharon	Rangeley Plt	Stetson	Whitefield
New Vineyard	Raymond	Stetsontown	Willimantic
Newburgh	Readfield	Stockton Springs	Wilton
Newcastle	Redington Township	Stoneham	Windham
Newfield	Richardsontown Twp	Stow	Windsor
Newport	Richmond	Strong	Winslow
Newry	Riley Township	Sumner	Winterport
Nobleboro	Ripley	Swanville	Winthrop
Norridgewock	Rockland	Sweden	Wiscasset
North Berwick	Rockport	Taunton Raynham	Woodstock
North Yarmouth	Rockwood Strip	Temple	Woolwich
Northport	Rome	The Forks	Wyman
Norway	Roxbury	Thomaston	Yarmouth
Oakland	Rumford	Thorndike	York
Ogunquit	Sabattus	Tomhegan	
Old Orchard Beach	Saco	Topsham	

TABLE OF CONTENTS	PAGE
I. INTRODUCTION	1
100. Purpose	1
101. Code Requirements	1
102. Compliance with Requirements	2
103. Special Cases	2
104. Written Confirmation	2
105. Application of Requirements	2
106. Advisory Service	2
107. Appeal to Maine Public Utilities Commission	2
II. GENERAL REQUIREMENTS	3
200. Application for Service	3
201. Municipal and State Certification	3
202. Service Requiring Extension of Lines	4
203. Installation of Service-Supply Lines	4
204. Temporary Service	4
205. Installation Contracts	5
206. Inspection Requirements	5
207. Capacity Limit	5
208. Disconnection for Violations	5
209. Moving of Equipment	6
210. Point of Delivery	6
211. Relocation of Delivery Point	6
212. Customer's Premises	6
213. Customer's Responsibility	7
214. Access to Premises	7
215. Continuity of Service	7
216. Protective Equipment	8
217. Customer Generation	8
218. Customer Constructed/Owned Lines	9
III. STANDARD CHARACTERISTICS	12
300. Standard Service Characteristics	12
A. 120 volts, single-phase, two-wire	12
B. 120/240 volts, single-phase, three-wire	12

TABLE OF CONTENTS	PAGE
C. 120/208 volts, single-phase (network), three-wire (from four-wire system)	12
D. 120/208 volts, three-phase, four-wire, wye	12
E. 120/240 volts, three-phase, four-wire, delta	13
F. 240 volts, three-phase, three-wire	13
G. 277/480 volts, three-phase, four-wire, wye	13
301. Direct Current or Two-Phase Service	13
302. Voltage Variation	13
303. Special Installations	14
304. Transformer Vaults and Metal Enclosures	14
305. Unbalanced Load	14
IV. OVERHEAD SERVICE	15
400. Service Drop	15
401. Service Drop Clearance	15
402. Rigid Conduit	16
403. Single Service Drop	16
404. Service/Meter Pole	16
405. New and Upgraded Service Entrances	17
406. Agricultural Central Distribution Point Service	20
407. Manufactured Buildings and Modular Homes	20
408. Mobile Homes and Manufactured Homes	20
409. Travel Trailers and Other Structures Not Suitable for Direct Attachment	23
V. SERVICE ENTRANCE CONDUCTORS	24
500. General	24
501. Conductor Identification	25
502. Location for Proper Clearances	25
503. Attachment Methods	25
504. Service Entrance Conduit	25
505. Service Mast Construction	26
VI. SERVICE (ENTRANCE) EQUIPMENT	27
600. Disconnecting Means	27
601. Sequence of Disconnecting Means and Meter Equipment	27

TABLE OF CONTENTS	PAGE
602. Metered and Unmetered Wires	28
603. Emergency or Standby Power	29
604. Changes in the Service Entrance	30
605. Standards of Certification of Generators and Interconnection Equipment	30
VII. GROUNDING AND BONDING	31
700. General	31
701. Grounding Electrode System	31
702. Bonding	32
703. Grounding Electrode Conductor	32
704. Lightning Protection System	33
705. Service Surge Protection	34
VIII. METERING EQUIPMENT	35
800. General	35
801. Metering Multi-Tenant Buildings	36
802. Meter Location	36
803. Meter Position	36
804. Pole Mounted Meters	37
805. Meter Pedestals	37
806. Multiconnection Points	38
807. Identification of Meters	38
808. Clearance for Metering Equipment	39
809. Self-Contained Metering	39
810. Instrument Transformer Metering	42
811. Instrument Transformer Cabinets	43
812. Mast or Building Mounted CT Installation	44
813. Padmount Transformer Installations	44
814. Switchboard/Switchgear Installations	45
IX. UNDERGROUND SERVICE	46
900. General	46
901. Customer Responsibility	46
902. Company Responsibility	47
903. Customer Costs	47

TABLE OF CONTENTS	PAGE
904. Loop Feed Requirement	47
905. Residential Secondary Services	48
906. Non-Residential Secondary Services	49
907. Underground Residential Distribution (URD) Developments	50
908. Padmount Transformers	51
909. Industrial and Commercial Primary Installations	52
910. Conduit Requirements/Specifications	53
911. Direct Burial Primary Cable	55
912. Burial Depths	56
913. Separation of Facilities	56
914. Risers (Pole)	57
915. Multiple Services From One Pole	58
916. Cable and Duct Maintenance	58
917. Transformer Vaults and Yards	59
918. Temporary Service From Underground Facilities	59
X. SERVICE FROM UNDERGROUND MAINS-URBAN	61
1000. General	61
1001. Duct Line Installation	61
1002. Terminal Box	61
1003. Service Conductors	61
1004. Protective Equipment	62
XI. UTILIZATION EQUIPMENT SPECIFICATIONS	63
1100. General	63
1101. Motor Specifications	63
1102. Protection and Control Specifications	64
1103. Power Factor Correction	64
1104. Harmonic Loads	65
XII. ILLUSTRATIONS	66
#1 980-31.1.1 / Single-Phase Cable Service 200 Amp Max	66
#2 980-31.1.2 / Conduit Service 400 Amp Max	67
#3 980-31.1.3 / Rigid Steel Mast Type Service to Low Building	68
#4 980-31.1.6.1 / Pole Mounted Service/Meter	69

TABLE OF CONTENTS	PAGE
#4 980-31.1.6.2 / Pole Mounted Service/Meter	70
#5 980-31.1.6.3 / Multi-Meter Service Pole/Pedestal	71
#6 980-31.4.3.1 / CATV Power Supply Installation	72
#7 980-31.1.4 / Temporary Service Structure 200 Amp Max	73
#8 980-31.3.1 / Underground Service 400 Amperes Max	74
#9 980-31.3.2.1 / Meter Pedestal Service 200 Amp Max	75
#10 980-31.3.3 / Underground Secondary Service Continuous Conduit	76
#11 980-31.3.2.2 / Meter Pedestal Service 400 Amp Max	77
#12 980-31.1.8 / Modular Metering, Typical	78
#13 980-31.1.7 / Self-Contained Meter Socket Connections	79
#14 980-31.2.4 / Wall Mounted Outdoor CT Cabinet & Overall Meter Enclosure	80
#15 980-32.1.1 / Pole-Mounted Outdoor Overall Meter Enclosure Mounting	81
#16 980-32.1.3 / Underground Outdoor Overall Meter Enclosure Mounting (1 – Single)	82
#17 980-32.3.2 / Underground Outdoor Overall Meter Enclosure Mounting (1 – Double)	83
#18 363-3 / Underground Cable Trench for Power Only	84
#19 363-4 / Underground Cable Installation Jointly Used Trench Horizontal Separation	85
#20 363-5 / Underground Cable Installation Jointly Used Trench Vertical Separation	86
#21 364 / Padmount Transformer and Cable Layout	87
#22 364-4 / Primary Junction Box Fiberglass Covers	88
#23 364-5 / Single-Phase Concrete Transformer Foundation 25 to 167 kVA	89
#23 364-6 / Single-Phase Concrete Transformer Foundation 25 to 167 kVA	90
#24 364-7 / Small 7' x 7' Three-Phase Transformer Foundation	91
#24 364-8 / Small 7' X 7' Three-Phase Transformer Foundation	92
#25 364-9 / Large 9' x 9' Three-Phase Transformer Foundation	93
#25 364-10 / Large 9' x 9' Three-Phase Transformer Foundation	94
#26 364-3 / Fiberglass Box Pad	95
#27 361 / Primary Cable Conduit/Riser Sizes	96

TABLE OF CONTENTS	PAGE
#28 361-3A / Conduit Standoff Bracket for Multiple Risers on One Pole	97
#28 361-3B / Conduit Standoff Bracket for Multiple Risers on One Pole	98
#29 361-2A / Primary URD Riser Single Conduit	99
#29 361-2B / Primary URD Riser Single Conduit	100
#30 361-1A / Secondary or Service URD Riser Single Conduit	101
#30 361-1B / Secondary or Service URD Riser Single Conduit	102
#31 980-31.6 / Allowable Secondary and Service Length	103
#32 980-31.3.4 / Underground Service Customer Owned Type MC Cable	104
#33 905A-6 / Heavy Duty 4' X 6' Junction Box for Primary Installations	105
#34 364-1 / Padmount Transformer Layout for Continuous Conduit System	106
NOTES	107

HANDBOOK
of
REQUIREMENTS
for
**ELECTRIC SERVICE AND
METER INSTALLATIONS**

Effective June 30, 2022

I. INTRODUCTION

100. Purpose

The intent of this handbook is to provide information to customers, electrical contractors, engineers, and architects in order that electrical installations may be connected to the company's system in a safe and uniform manner. This handbook is meant to provide a construction standard and is not meant to assist in determining rates. For rates, please see CMPCO.com and search pricing.

This handbook is filed with the Maine Public Utilities Commission (MPUC), and it is in conformance with the MPUC's Chapter 320, Service Standards for Electric Utilities.

101. Code Requirements

The company, by law (Title 35A M.R.S.A. Section 2305A), is required to design, construct, operate and maintain its lines and equipment in conformance with the applicable provisions of the most recent edition of the **National Electrical Safety Code (NESC)**.

The customer requirements of this handbook are based upon the applicable provisions of the most recent edition of the **National Electrical Code (NEC)**, as approved by the National Fire Protection Association, and said Code is hereby made a part of this handbook by reference. Any additional requirements are established in the interests of safety and convenience. Municipal and State requirements, insofar as they may conflict with anything contained herein, will take precedence. The local or State electrical inspector is the "**authority having jurisdiction**" and is, therefore, responsible for interpretation and enforcement of the NEC. In accordance with NEC Section 90.4, the "authority having jurisdiction" may, by special permission (written consent), waive specific requirements in the NEC or permit alternative methods.

102. Compliance With Requirements

The customer's installation, before being connected to the lines of the company, shall be in compliance with the requirements contained in this handbook, the NEC, and any other requirements mandated by Federal law or local ordinance.

103. Special Cases

Special cases may warrant departure from the requirements in this handbook. Any such departure will not be considered as establishing a precedent, nor be considered as a waiver of the company's right to enforce any of the requirements contained herein.

104. Written Confirmation

The company will confirm in writing, upon request, all information given regarding service characteristics, applicable rate, service entrances and meter locations. The company is not responsible for misunderstandings of any nature which may result from information given orally, unless confirmed in writing. In order to avoid delays and possible expensive changes, the above information should always be obtained before purchasing equipment or starting construction.

105. Application Of Requirements

These requirements apply to all new installations and to any existing installations which are being significantly altered or which are specifically covered hereinafter.

106. Advisory Service

All persons are encouraged to make use of the advisory services provided by the company. This assistance may avoid delays in service installation and suggestions regarding energy management and application of electrical equipment may result in greater satisfaction and more efficient use of electric service.

107. Appeal To Maine Public Utilities Commission

If, after consultation with the appropriate company personnel, there continues to be a dispute about the application of any of these requirements, the customer may appeal to the Maine Public Utilities Commission for assistance in resolving the dispute. It is not intended that the MPUC will interpret any provision of the National Electrical Code.

II. General Requirements

200. Application For Service

Applications for new service connections or for alterations in existing connections shall be made by calling **800.750.4000** (for RESIDENTIAL) or **800.565.3181** (for COMMERCIAL & INDUSTRIAL). The application shall be made as far in advance as possible to assure lead time and availability of necessary materials. Advice will be given as to the applicable CMP rates and type of service available. **The location for the service entrance, meter, point of attachment of the company's service drop, as well as company transformers and poles, must be reviewed and approved by the company before any wiring is installed.** NOTE: The customer may be billed whenever wiring installed without prior company approval results in an additional expense to the company.

Wiring should not be started, equipment purchased, nor any load added to existing services until all necessary negotiations have been completed and the company has advised that it can supply the required service. Customers' specifications and contracts for electric wiring and equipment should conform to these Requirements. Plans and specifications for industrial and commercial facilities and multiple occupancy buildings, including housing, shall be submitted in duplicate, indicating the size of the building in square-feet and listing the connected load by class, such as cooking, heating, lighting, motors' (indicate largest size), etc.

The customer shall give proper notice to Customer Service of an increase or decrease proposed in connected load or of any proposed change in characteristics, purpose of use, or location of load.

201. Municipal And State Certification

A. FORM 1190

The company cannot install services to any lot until it receives written authorization from the municipality that the lot complies with all applicable shoreland zoning and subdivision laws, or other written arrangements have been made between the company and the municipal officers as stated in Title 30A M.R.S.A. Section 4406 and Title 38 M.R.S.A. Section 444. Services should not be installed until an authorized municipal officer issues the required certification on CMP form 1190, unless the company gives the contractor written notification that it is not necessary to obtain form 1190.

B. FORM 1360 OR STATE SINGLE-FAMILY DWELLING APPLICATION

Maine law (Title 32 M.R.S.A. § 1102-D and Title 32 M.R.S.A. § 1105) prohibits the company from activating the electricity to a newly constructed single-family dwelling until the company receives certification by a State or local electrical inspector, master electrician or limited electrician in house wiring; that the wiring complies with the NEC.

Note: the **Law requires** certification for any new (first time) electrical installation/electric service made in/on or connected to a single-family dwelling constructed after July 1, 1987. The **Law does not apply** to the installation of mobile/manufactured or modular home wiring or services.

CMP form 1360 is used where there is no local electrical inspector, and the **electrician** is certifying the complete wiring installation. The State Single-Family Dwelling Application is used when the homeowner does the wiring, and the State inspector certifies the wiring.

202. Service Requiring Extension of Lines

Line extensions shall be in accordance with the provisions of the MPUC's Chapter 395 "Construction Standards, Ownership, Cost Allocation and Customer Charges Rules for Electric Distribution Line Extensions and Service Drops" and, the company's filed tariff or Term & Condition (T&C) on "Extensions." See paragraph 219 of this handbook for more details on customer constructed/owned lines.

203. Installation of Service Supply Lines

The company is not required to install service supply lines prior to the time that the wiring of the premises is actually in progress and the structure sufficiently completed to provide a safe and suitable terminus for the service supply lines.

204. Temporary Service

Customers taking service on a temporary basis are required to pay an amount equivalent to the cost of installing and removing the company's service facilities, including the nonsalvable costs of material used. Temporary service, provided typically for building construction purposes, is intended to be used for up to 6 months at a location where the facilities devoted especially to the service are not expected to have further usefulness at that location after the temporary period. There shall be no other attachments to the temporary structure; and, if it

becomes unsafe, service may be disconnected (See paragraph 209). In special cases advance payment is required. See illustration number 7 in Section XII for overhead temporary service structure requirements. See Par. 918 and illustration numbers 9 and 11 for underground temporary or permanent service structure requirements.

205. Installation Contracts

When contracts for electric wiring or equipment are prepared by contractors, architects, or engineers, it is suggested that such contracts include the specification that "all materials, labor and workmanship be in full accordance with the latest requirements of: the NEC, all municipal, State and National authorities having jurisdiction, and Central Maine Power company."

206. Inspection Requirements

In municipalities where electrical inspections are required by local authorities, certificates of approval must be received in company's local Service Center before installations will be connected to the company's distribution system. Such certificates are to be obtained from the "authority having jurisdiction" by the customer or contractor.

Where local authorities do not require inspection certificates, any required State permits or certificate of inspection shall be received in the company's local Service Center before temporary, new, or upgraded services are connected. Refer to paragraph 201 for specific certification requirements. The customer is advised to contact the company's local Service Center to verify the inspection requirements.

The company shall not be responsible for the installation or maintenance of the customer's electrical equipment, nor shall there be any duty or obligation on the part of the company to inspect the same.

207. Capacity Limit

The company reserves the right to install protective apparatus to disconnect service if the company's capacity at that point is exceeded.

208. Disconnection For Violations

Subject to the Maine Public Utilities Commissions' Chapters 815 and 860, the company may refuse to connect or continue service already connected if in its judgment the customer's equipment, or use thereof, creates a dangerous condition, or might detrimentally affect the equipment of the company or adversely affect service to other customers.

209. Moving of Equipment

When electrical equipment is brought into the territory served by the company, or is moved within said territory, it must be adapted by the customer to the characteristics of the service available at the new location.

210. Point of Delivery

The company will designate a point at which the customer shall terminate his wiring and facilities for connection to the service-supply lines of the company, but such information does not constitute an agreement or obligation on the part of the company to furnish service.

The NEC refers to this point as the "Service Point"

The company may have some of its equipment, such as metering, on the customer's side of the Point of Delivery/Service Point.

211. Relocation of Delivery Point

In the event the company is required to place underground any portion of its distribution system or is required to change the location of any poles or its overhead distribution system, a new point of delivery will, if necessary, be designated by the company and the customer will be required, at his own expense, to make any change in his wiring system in connection therewith.

The company will reimburse the customer or pay for the cost of such changes if the delivery point is changed for the reasons stated above at the sole request and convenience of the company.

The company will charge a customer for all work performed by it at the customer's request in changing the location of any poles, services, meters, or other equipment owned and installed by the company.

212. Customer's Premises

The company shall not be liable for damage to the person or property of the customer or any other persons arising from the use of electricity or the presence of the company's equipment on the customer's premises. All property owned by the company and located on the customer's premises shall be deemed to be personal property and title thereto shall remain with the company, and the company shall have the right at the termination of service to remove all of its property whether affixed to the realty or not.

213. Customer's Responsibility

The customer shall be responsible for the safekeeping of the property of the company on the customer's premises and, in the event of damage to it, shall pay to the company any cost of inspection and repairs. The customer shall protect the equipment of the company on the premises and shall not permit any person, except an authorized representative of the company, to break any seals, do any work on or attach anything to any meter or other company apparatus located on the customer's premises except with the written authorization of the company. The customer should notify the company for operation, maintenance, or relocation of company owned equipment.

The customer shall provide transportation of all company line material, tools, employees, and equipment from the point of reasonable access to the location where service is to be performed whenever operation and maintenance is required on extensions located in remote areas where access by standard company transportation is not possible. In lieu thereof, the customer or customers served by the line shall pay the transportation costs incurred directly by the company. See paragraph 219 for details on customer constructed lines.

214. Access To Premises

The company shall have the right of access, by the company's standard vehicles and equipment, to a customer's premises and to all property furnished by the company installed therein at all reasonable times during which service is furnished to the customer, and on or after its termination, for the purpose of reading meters, or inspection and repair of devices used in connection with its service, or removing its property, or for any other proper purpose.

The customer, at their expense, shall maintain suitable and safe access, by the company's standard vehicles and equipment, to all equipment owned by the company on the customer's property. Access shall be minimum 10-feet in width, 15-feet at equipment location, maintained year-round and suitable to support a 34,000 lb vehicle. If the customer's property is secured by a gate, chain or similar device, the customer shall install the device to allow installation of a company owned lock for access to this property.

215. Continuity of Service

The company will use reasonable diligence to provide a continuous, regular, and uninterrupted supply of service. Conditions may arise when the supply of service is subject to interruption, impairment,

or change from normal standards of delivery for such reasons as accidents, strikes, or causes beyond its control, or to curtailment or change in characteristics of delivery when considered necessary for protection of life or property, for repairs or improvements to facilities, or for the best interests of customers in general. When interruptions are necessary for repairs or improvements to facilities, the company shall give reasonable notice to the customers affected if practicable; or in an emergency when such notification would be impracticable, such interruptions will be made without notice.

Should the supply of service be so curtailed or changed, or should it be interrupted or become impaired because of accident, strike, legal process, Federal, State, or municipal interference or any cause whatsoever beyond the company's control, and except as caused by willful default or willful neglect on its part, the company shall not be liable for damages, direct or consequential, resulting from such interruption, impairment, curtailment or change.

216. Protective Equipment

In cases of emergency, it may become necessary to interrupt service for short periods without notice when repairs or changes require such procedure, and also to restore service without notice when such work is completed. Any equipment which might endanger life or damage property under the above conditions must be provided with suitable automatic protective devices by the customer.

All motors and electronic equipment such as computers and microprocessors, shall be controlled and protected, by the customer, from damage caused by single phasing or abnormal voltage conditions. Such disturbances are inherent in all supply systems.

The company cannot be held responsible for damages caused by the customer's failure to provide adequate protection.

217. Customer Generation

The following general requirements apply to customer generating facilities designed to operate in parallel with the company's electrical system and those which are designed to operate isolated from the company's system. Specific requirements and specifications for various types and sizes of customer facilities shall be obtained from the company prior to installation.

A. PARALLEL OPERATION

The company will permit customers to operate generating equipment in parallel with its electric system whenever it can be done without adversely affecting the general public or company equipment or personnel. Operating in parallel means the customer's generator is interconnected to simultaneously serve the same load as the company's system. Such interconnection must be in compliance with Federal, State and local regulations as well as company requirements, MPUC requirements (Chapter 324), and NEC Article 705.

All such installations must be inspected and approved in writing by the company before being allowed to operate in parallel with the company's electrical system.

A contract/agreement is required for all generators that operate in parallel with the company.

Inquiries for interconnection of customer owned generation should be referred to the Interconnection Services Department for assistance.

B. NON PARALLEL OPERATION (EMERGENCY OR STANDBY)

Where a customer makes provision for or installs a generator for the purpose of supplying all or a part of the load in the event of an interruption in supply of service from the company's circuit, the customer's wiring shall be so arranged that no electrical connection can occur between the company's service and the customer's emergency or standby source of supply. This will require the installation of a double throw switch, or an equivalent arrangement approved by the company, that will insure the safety of both company employees and the customer.

The customer must notify the company's local Service Coordinator in advance of installing generating equipment and obtain approval of the method of connection. See paragraph 603 for more details on equipment and connection requirements for emergency or standby power connected to service entrance conductors or equipment.

218. Customer Constructed/Owned Lines

A. GENERAL

Electric distribution line extensions may be constructed by a contractor and owned by the customer in accordance with: the provisions of the MPUC's Chapter 395, "Construction Standards, Ownership, Cost Allocation, and Customer Charges Rules for Electric

Distribution Line Extensions and Service Drops” and the company’s filed tariff (T&C) on “Extensions.

Customers must contact the company prior to the start of construction of “Customer Constructed/Owned Lines” to ensure that the line will be built in such a manner that it can be connected to CMP’s distribution system in accordance with all applicable rules and regulations.

B. CONSTRUCTION

Extensions may be constructed by a private line contractor, and **owned** by the customer, if the line will serve only **one customer** (as defined in the MPUC’s Chapter 395). In this case, the property owner may retain ownership of the line and the company will then have no responsibility for repair and maintenance of the line, including tree trimming and storm damage repair.

In the event the line will serve **multiple customers**, such as in a development or subdivision, the line may be **constructed** by a private line contractor; however, it shall be owned by the company. In this case, the customer shall be responsible for **all costs** associated with the transfer of ownership as specified in the MPUC’s Chapter 395 and the company’s filed tariff (T&C) on “Extensions.”

For any customer-owned line extension, the customer may locate the service equipment, including the meter enclosure, on the final pole of the line extension. This pole may also be the location of CMP’s transformer, under the following conditions:

- All secondary conductors on the pole shall be run in conduit;
- The service equipment will be relocated off the pole at the owner’s expense should the line be conveyed to CMP for any reason (the customer should contact the company prior to relocating any service equipment to discuss the new location);
- No non-utility attachments (i.e., satellite dishes, clotheslines, basketball hoops, animal runs, etc.) shall be allowed on the pole;
- Access by standard utility vehicles to the pole shall be maintained at all times by the owner at his/her expense.

When the customer-owned line includes a primary underground that is feeding a single customer and owned by that customer, it may be constructed as a radial (in lieu of a loop) feed system. (See also, the company’s Terms & Conditions 7.4 (B)(11) (i), 7.4 (B)(12) (iii) and 7.5 (E); and paragraph 904 of this handbook.

C. CUSTOMER OBLIGATIONS

Prior to purchasing materials, the contractor should contact the company to determine the appropriate wire size and type and the appropriate insulation level for the proposed line.

Before the company shall be obligated to energize a private line extension, the contractor or customer shall:

- Provide the company a plan of the line extension sufficient for the company to include the private line on the company’s property records or reimburses the company for the cost of preparing such a plan. The plan should detail the location or placement of the materials used, as identified in a materials list (or other such documentation) showing that the materials are listed on the company’s Contractor Item Catalog contained in CMP’s Distribution Construction Standards for private line construction. To purchase a copy of the Item Catalog and Construction Standards, contact the company’s Manager of Distribution Engineering.
- Build the line extension in accordance with the NESC, the company’s line construction standards, and any other requirements contained in the company’s filed tariffs on “Extensions.”
- Provide tree/vegetation clearance from any overhead primary line per the following specification: a minimum of 8-feet horizontally, 15-feet vertically above and to the ground beneath, any conductor.
- Enter into a customer-owned line extension contract which the company will record at the appropriate Registry of Deeds.
- Obtain: a) inspection by a qualified company employee to determine whether the line extension is safe; or b) certification in writing by a Maine licensed Professional Engineer that the line extension is safe, reliable, and constructed in compliance with the NESC and company’s line construction standards.
- Provide to the company documentation of the total labor, total equipment, and total material costs.

III. STANDARD CHARACTERISTICS

300. Standard Service Characteristics

The following service characteristics are generally standard; however, all types of service are not available in all localities, those that are available shall be obtained from the company before any wiring is installed or equipment purchased. In cases of multiple occupancy installations, the combined load may be such that the characteristics of the service required will be different from that which the individual customer's loads might indicate. In such cases the company reserves the right to determine the type of service which will be supplied at 60 hertz. The maximum capacities as listed below may be exceeded, under certain conditions, with prior company approval. **Metering note:** see paragraph 809 and 810 of this handbook for metering options.

A. 120 VOLTS, SINGLE-PHASE, TWO-WIRE, (UP TO AND INCLUDING 60 AMP)

For highway signs, trailers, traffic controllers, CATV amplifiers or other small power loads. The service from the company's facilities up to, and including, the meter shall be a 120/240 volt, single-phase, three-wire circuit. Company approval must always be obtained in advance. Refer to paragraph 409 for special requirements for travel trailers.

B. 120/240 VOLTS, SINGLE-PHASE, THREE-WIRE

For general lighting and/or heating and cooking, and small power loads with individual motors generally not over 5 hp.

Where the total load exceeds 50 kVA, the company may, at its option, require the customer to arrange the wiring for three-phase service.

C. 120/208 VOLTS, SINGLE-PHASE (NETWORK), THREE-WIRE, (FROM FOUR-WIRE SYSTEM)

For general lighting and/or heating and cooking, and small power loads with motors generally not over 5 hp. Where the total load exceeds 40 kVA, the company may, at its option, require the customer to arrange the wiring for three-phase, four-wire service.

D. 120/208 VOLTS, THREE-PHASE, FOUR-WIRE, WYE

For large lighting loads, or combination lighting, heating/cooking, and power. Single-phase load shall be balanced between phases in accordance with paragraph 305. See also paragraph 302.

E. 277/480 VOLTS, THREE-PHASE, FOUR-WIRE, WYE

For power and general service installations typically having demands in excess of 50 kVA. Single-phase load shall be balanced between phases in accordance with paragraph 305.

F. 240/480 VOLTS, SINGLE-PHASE, THREE-WIRE

For power and general service where the higher voltage is required to limit voltage drop in secondary feeds and three-phase power is not readily available (available from company padmount transformers where load does not exceed 50 kVA). This is not intended for residential service.

G. SERVICE VOLTAGES HIGHER THAN 480 VOLTS

Available only by negotiation with the company. The size and type of customer's load must warrant such an installation.

301. Direct Current or Two-Phase Service

No new service installation or provisions for increased loads will be made for either direct current, two-phase, or delta alternating current services.

302. Voltage Variation

The company will maintain the voltage delivered to its customers within the limits prescribed in "A" and "B" below, as required in the MPUC's Chapter 320. This voltage will be maintained to the customer's service entrance panel, provided that all systems up to that point meet CMP Standards. For three-phase services, this "maintained" voltage can only be assured when all three primary phases are utilized, and all three transformer windings are connected. Therefore, three primary phases will be required for the three-phase services listed in paragraph 300. For residential services, refer to the Table on illustration number 31 in Section XII for "Allowable Secondary and Service Length."

A. For service rendered principally for residential or commercial purposes the normal voltage variation shall not exceed plus or minus five percent (+ or - 5%) from the standard voltage for any period longer than one (1) minute.

B. For service rendered principally for power purposes the normal voltage variation shall not exceed plus or minus ten percent (+ or - 10%) from the standard voltage for any period longer than one (1) minute.

303. Special Installations

The customer will be required to pay the cost of any special installation necessary for service at other than the standard voltages listed previously or for service with closer voltage regulation than required for standard practice.

304. Transformer Vaults and Metal Enclosures

Where high-capacity services are required, or where an open outdoor location for transformers is not available, the company may require the customer to furnish and properly maintain a suitable vault or metal enclosure on the premises for the necessary transformers and protective equipment. Such transformer vaults or enclosures must meet the requirements of the NEC and be provided with safe, secure, and readily accessible outside access. Vault and enclosure specifications are subject to advance approval by the company. Information will be furnished on request.

305. Unbalanced Load

The customer shall at all times take and use energy in such a manner that the load current will be balanced between phases to within nominally 10%. In the event of unbalanced polyphase loads, the company reserves the right to require the customer to make the necessary changes at the customer's expense to correct the unsatisfactory condition, or to compute the demand used for billing purposes on the assumption that the load on each phase is equal to that on the greatest phase.

IV. OVERHEAD SERVICE

400. Service Drop

For single-phase service, the company will furnish, install, own, and maintain the overhead service drop, running from its secondary distribution system to a designated point on the customer's premises. It shall be the responsibility of the owner or contractor to have the point of attachment determined by the company so that a solid fastening for the service drop may be incorporated in the building. The customer shall install a standard hook or eye bolt, furnished by the company, in accordance with NEC, Section 230.51. For services to low buildings or where the style of building construction does not readily permit the installation of the standard hook or eye bolt, the customer will, with company approval, install a mast type service or provide an alternate means of attachment for the service drop. Refer to illustration numbers 3, in Section XII for a Mast Type Service.

In accordance with NEC Section 230.27, service drops shall be attached to buildings or other structures by fittings identified for use with service conductors. Per NEC Section 230.10, "vegetation such as trees shall not be used for support of overhead service conductors."

For polyphase service, the customer shall be responsible for the cost of any overhead service drop.

401. Service Drop Clearance

In general, the ground clearance for triplex and quadraplex service drops, **including drip loops**, shall be not less than 12-feet for spaces accessible to pedestrians only, 15-feet over residential driveways, 18-feet over public ways, and 24-feet over railroads. Additionally, a 20-foot clearance over State/State Aid roads is recommended to provide adequate clearance for future highway construction.

Where the height of attachment to a building does not permit the service drop, **including the drip loop**, to meet the above clearances, the ground clearance for building services, **including the drip loop**, with voltages of **150 volts or less to ground** and consisting of triplex or quadraplex cable may be reduced to 10-feet over areas accessible to pedestrians only and 12-feet over residential driveways. For temporary services, see illustration numbers 7 in Section XII.

The above clearances are the minimum required at 120°F final sag or 32°F and ½-inch ice, whichever produces the greatest sag (NESC requirement).

In order to obtain satisfactory clearances with low types of buildings, it may be necessary that special construction, as needed to provide a suitable point of attachment for the service drop, be furnished and installed by the customer, subject to the company's approval. See illustration number 3 in Section XII for rigid steel mast type construction.

The above clearances are based upon NESC and NEC minimum requirements.

402. Rigid Conduit

In order to avoid damage to meter enclosures or service entrance equipment, rigid conduit shall not be installed between a pole and a building where the pole is not solidly attached to the building and independent movement might occur.

403. Single Service Drop

Only one service drop connected to the same overhead mains will be attached to anyone building, and only one set of service entrance conductors shall be connected to each service drop except in cases specifically permitted by the NEC, Section 230.2, or where special permission has been obtained from the "authority having jurisdiction." The drop may consist of parallel service cables for capacity. Overhead services may be provided up to and including 1,000 Ampere total switch frame capacity unless limited by construction problems. Overhead secondaries shall be limited to two - four conductor (three-phase and one neutral/messenger) cables 336.4 kCM (or smaller). Where greater capacity is required, other types of construction such as underground service must be used. Refer to Section IX.

404. Service Pole

A. METER POLE

In lieu of running a regular service drop to a building, the company may terminate its electric service conductors on a customer owned pole or structure suitably located on the customer's property. In such event, the customer shall furnish, install, own, and maintain all facilities beyond this pole.

The company requires the meter enclosure and service disconnect to be mounted on the service/meter pole. Note: Metered and unmetered wires are not allowed in the same conduit, raceway or gutter. A riser (only) pole is not considered to be a service/meter pole. Refer to illustration number 4 (single meter) or No. 5 (multiple

meter) in Section XII for construction details.

Refer to paragraph 219 for the requirements on interconnecting company lines with customer-owned line extensions.

B. SERVICE POLE - NO METER

In the event a pole is required to connect a service cable to accommodate a road crossing, terrain or to attach a private underground service cable, a customer may choose to install a Service Pole. Key characteristics of a Service Pole are:

1. The meter enclosure cannot be installed on the pole.
2. The pole must be owned and maintained by the customer and installed per CMP construction standards.
3. CMP will own and maintain the service cable from the previously existing (take-off) pole to the service pole and to the point of attachment if all overhead cable. If the customer chooses to attach a private underground service cable to the pole, the customer will install, own, and maintain the underground portion of the service.
4. The distance from the previously existing (take-off) pole to the point of attachment cannot exceed 150' if the take-pole is on the same side of the road, 200' if the service cable will cross a road. Note: If a private underground service cable will be attached to the Service Pole, the maximum distance from the take-off pole to the Service pole may be 150' or 200' respectively. Underground service cables must be sized to accommodate the distance from the transformer to the primary service panel.
5. The customer can install the pole privately or hire CMP to install the Service Pole and Anchor. In either case, the customer will be responsible to own and maintain the pole/anchor.
6. Only one customer can be served from a Service Pole.
7. The pole must be installed on private property.

405. New and Upgraded Service Entrances

A. GENERAL

Company seals will be cut or removed **only** by qualified company employees.

Any expenses in connection with the relocation or change of company facilities as a result of a customer change or relocation of the **service entrance** shall be borne by the customer.

The customer shall be responsible for installing the service entrance which encompasses the weatherhead through the service disconnecting device/overcurrent protection and includes the service entrance grounding.

A company employee will work with the customer and/or electrician in determining a suitable meter location, point of attachment of the service drop, and location of the service head. The meter must be in a safe and readily accessible location.

All service entrance installations must be approved by the company and a State or municipal inspector. Any required local or State permits or certificates of inspection shall be received by the company before new or upgraded services are connected.

All electrical connections to company secondaries must be made by a company employee. Outdoor work may be affected by weather, and scheduling may be subject to change.

B. NEW SERVICE ENTRANCE

1. Only the customer may apply for new service and should do so by calling **800.750.4000** (for Residential) or **800.565.3181** (for Commercial & Industrial).
2. In the case where a municipal inspection is not required, the customer/electrician (having obtained any required State permits or certificate of inspection) will notify the company when the service entrance is ready for connection and the company will arrange to inspect the service entrance for compliance with company requirements. Following company approval, the company will install the service drop and meter, and energize the service.

C. UPGRADED SERVICE ENTRANCE IN A NEW LOCATION

1. The customer or customer's electrician must notify the company by calling **800.750.4000** (for Residential) or **800.565.3181** (for Commercial & Industrial) of intent to upgrade the service entrance.
2. The electrician will install the new service entrance. Where rewiring requires service from the new location on a temporary basis, a jumper cable should be installed by the electrician to energize the **load side** of the new main switch from the **load side** of the old main switch. The new main switch will remain in the open position.

3. In the case where a municipal inspection is not required, the customer/electrician will advise when the new equipment is ready for connection and the company will arrange to inspect the service entrance for compliance with company requirements. Following approval, the company will install the new service drop and meter, and energize the service. The old main switch will be opened, the old cable cut clear and the new main switch closed to provide service from the new installation. The customer/electrician must arrange for access to the premises and may be required to do the necessary switching.
4. If, in the opinion of the electrician, the procedure in paragraphs 2 and 3 above presents undue safety risk, the company will work with the electrician to make other mutually acceptable arrangements to de-energize and re-energize the service.

D. UPGRADED SERVICE ENTRANCE IN THE SAME LOCATION

1. The customer or customer's electrician must notify the company by call **800.750.4000** (for Residential) or **800.565.3181** (for Commercial & Industrial) of intent to upgrade the service entrance.
2. Upon request, the company will float the meter enclosure and reseal the meter enclosure so that the electrician may install the new enclosure and riser cable in the same location on the building.
3. The electrician will install the new enclosure and service entrance cable and the new main switch. In order to maintain service, the electrician may provide a temporary jumper to energize the load side of the new main switch from the **load side** of the old main switch, leaving the new main switch in the open position.
4. The electrician will make an appointment with the company for the company to disconnect the old service drop while the electrician is removing the old service entrance conductors and installing the new conductors between the new meter enclosure and the new main switch using the same hole in the building. Any switching of the customer's equipment and the removal of the temporary jumper will be the responsibility of the electrician.
5. If, in the opinion of the electrician, the procedure in paragraphs 3 and 4 above presents undue safety risk, the company will work with the electrician to make other mutually acceptable arrangements to de-energize and re-energize the service.

406. Agricultural Central Distribution Point Service

Services to more than one agricultural building may be supplied from a central distribution point in accordance with NEC Section 547.9. When services to agricultural buildings are located on the opposite sides of the public way, they shall be supplied through separate meters.

Prior company approval is required for a central distribution point service. Prior approval of the “authority having jurisdiction” is advised.

407. Manufactured Buildings and Modular Homes

A **manufactured building** (a building made or assembled in manufacturing facilities for installation, or for assembly and installation, on the building site) **may have the service equipment installed in or on the structure**; provided the structure is of sufficiently sound construction and complies with applicable building codes, such as, “**BOCA.**” Manufactured buildings are covered in NEC Article 550, and electrical service to them shall comply with the standard services in this handbook and NEC Article 230.

A “manufactured building” that complies with NEC Article 550 and the applicable building codes as approved by the Maine Manufactured Housing Board, **may be designed and constructed for use as a dwelling unit** (usually referred to as a **modular home**). These homes, as defined in Maine law (Title 10, Chapter 951, Manufactured Housing Act, § 9002), are “Manufactured housing,” type B, “meaning structures, transportable in one or more sections, which are **not constructed on a permanent chassis** and are designed to be used as dwellings on foundations.” Typically, there is a label/information sheet (inside the cabinet below the kitchen sink) indicating the applicable codes to which the building was constructed, as well as, certification of compliance as State of Maine “**certified manufactured housing.**” A modular home is typically a ranch or Cape Cod style home furnished with a main panel/disconnect and overcurrent device “suitable for use as service equipment,” and therefore, may be served in the same manner as a “stick-built” (on-site) home (per NEC Article 230).

408. Mobile Homes and Manufactured Homes

A. MOBILE HOMES

A **mobile home** (factory-assembled structure or structures, transportable in one or more sections, that is **built on a permanent chassis (heavy I-beams)** and designed to be used as a dwelling without a permanent foundation) **shall have the service**

equipment mounted separate from the structure in accordance with **NEC Section 550.32 (A)** and illustration numbers 4, 5 or 9 in Section XII of this handbook. Note, the term “mobile home” (for purposes of this handbook) refers to a structure **built prior to June 15, 1976**. Company approved prewired combination meter and service equipment may be used (See the “Supplement” located in the inside back cover of this handbook).

The company is not responsible for enforcement of the rules, e.g. NEC, beyond the service disconnecting means/overcurrent protection and service grounding; therefore, the company will not be determining whether or not an additional disconnect is required (within 30-feet of the unit) as a condition for activation of the electric service. As with any service, however, the company reserves the right to refuse connection when doing so would create a dangerous or unsafe condition. Grounding at the disconnecting means shall be in accordance with NEC Section 250.32. The service cable installation (on the line side of the service disconnecting means) must meet all company standards for underground service, as applicable.

In accordance with NEC Article 550, the service equipment shall be rated at not less than 100 amperes, and provisions shall be made for connecting a mobile home “feeder assembly” (4 insulated conductors) by a permanent wiring method. Power outlets used as mobile home service equipment shall also be permitted to contain receptacles rated up to 50 amperes with appropriate overcurrent protection.

B. MANUFACTURED HOMES

A manufactured home (a structure, transportable in one or more sections, that when erected on site is 320 square-feet, or more; is **built on a chassis (heavy I-beams)** and labeled “**manufactured home**”; and is designed to be used as a dwelling with or without a permanent foundation), in accordance with **NEC Section 550.32 (B)**, **is permitted to have the service equipment installed in or on the structure**, provided that all of the conditions of 1 thru 7 below are met. (Note, the term “manufactured home” (for purposes of this handbook) refers to a structure built since **June 15, 1976**; which should have a **HUD label** indicating that it complies with the Federal standard (HUD 24 CFR, Part 3280). These homes are still often called mobile homes, single-wide or double-wide).

1. In accordance with the manufacturer’s written instruction: the manufactured home must be **secured in place** by an anchoring

system, **or, installed on and secured to** a permanent foundation in a manner acceptable to the Authority Having Jurisdiction (AHJ) or the local code enforcement officer;

2. The **service equipment** is located in accordance with the manufacturer's instruction and is installed in compliance with NEC Article 230 and Section VI of this handbook, and is acceptable to the AHJ (Note, "service equipment" shall be marked "suitable for use as service equipment" and shall include a "service disconnect" per NEC Sections 230.66 and 230.70;)
3. Means are provided for the connection of a grounding electrode conductor to the service equipment and routing it outside the structure.
4. Bonding and grounding of the service are in accordance with NEC Article 250 and Section VII of this handbook;
5. Grounding the service equipment complies with the manufacturer's written installation instructions;
6. The minimum size grounding electrode conductor complies with the manufacturer's instruction; and
7. A red warning label is mounted on or adjacent to the service equipment stating the following:

WARNING
DO NOT PROVIDE ELECTRICAL POWER
UNTIL THE GROUNDING ELECTRODE(S)
IS INSTALLED AND CONNECTED
(SEE INSTALLATION INSTRUCTIONS).

NOTE: **Where the service equipment is not installed in or on the unit** (service equipment is mounted separate from the structure), the installation shall comply with the provisions of paragraph 408. (A) of this handbook.

If the company fails a "manufactured home" service because it believes any of the above rules have not been met, and the customer/ electrician does not agree; then, the issue should be referred to the AHJ (State or local electrical inspector).

409. Travel Trailers and Other Structures Not Suitable For Direct Service Attachment

An approved raintight service disconnecting means rated at not less than 60 amperes and with appropriate overcurrent protection shall be installed at the meter location. (Refer to illustration numbers 4, 5 or 9 in Section XII.) For recreational vehicles, the disconnecting means shall generally be located near the point of entrance of supply conductors in compliance with NEC Article 551.

V. SERVICE ENTRANCE CONDUCTORS

500. General

For overhead service, the service entrance conductors comprise that part of the service which extends from the point of attachment of the overhead service drop on the building or structure to the service equipment, i.e., disconnecting means and overcurrent protection (breaker or switch-fuse). For underground service, the service entrance conductors run from the "point of connection" of the underground service lateral to the service equipment. The service lateral typically terminates in the meter enclosure on the outside of the building wall. Where there is no meter enclosure or terminal box, the "point of connection" is considered to be where the conductors penetrate the building wall.

All service entrance conductors shall be service entrance cable or conductors installed in rigid or intermediate metal conduit, electrical metallic tubing, or rigid non metallic conduit recognized for use above ground as permitted by NEC Article 352. See Par. 504 of this Handbook for conduit details. Conduit is suggested, and may be required by local code, where the exterior construction of the building consists of rough stone, stucco or metal siding.

On the line side of the meter, service entrance cable or conduit shall not be installed within the building wall or concealed in any way. On the load side of the meter, service entrance cable or conduit must be protected against physical damage per NEC Sections 230.50 and 300.4 and supported per 230.51(A). All services shall be installed in accordance with NEC Article 230.

For overhead service entrance conductors 4/0 and smaller size, the conductors must extend at least 24-inches beyond the weatherhead to accommodate connection to the company's service drop. For larger than 4/0 size (or paralleled), the conductors must extend at least 36-inches beyond the weatherhead. The weatherhead should be installed above the level of the point of attachment of the service drop with suitable drip loops provided to prevent the entrance of moisture.

For overhead service connection, the company will provide and install connectors and covers for conventional copper or aluminum conductors up to and including 500 kCM or multiples thereof. For service entrance conductors larger than 500 kCM, the customer must provide connectors and insulating covers which are acceptable to the company. Advance approval is required.

501. Conductor Identification

The neutral or grounded conductor shall be positively identified (generally by white color) in accordance with NEC Section 200.6.

Note: **In no case** shall a phase conductor be identified with white or gray.

The conductor with the higher phase voltage to ground on a four-wire delta service shall be positively identified (orange color) in accordance with NEC Section 230.56.

502. Location For Proper Clearances

Meter enclosures, service entrance cable, conduit, and drip loops, shall always be located so that the proper clearances will be provided for rain spouts, fire escapes, telephone wires, windows, blinds, doors and lightning rod conductors, as required by other sections of this handbook and the NEC.

503. Attachment Methods

Service entrance cable or conduit shall be securely fastened to the building with suitable rustproof clips and fasteners. Expansion shields or their equivalent shall be used in brick, concrete, or other masonry construction. Cable entrances into buildings shall be not less than six-inches above final grade, adequately protected if exposed to physical damage, and weatherproofed at the point of building entrance.

All conduit fittings, on the line side of the meter, which contain service entrance conductors shall be placed so as to be fully exposed to view. Fittings shall be made watertight unless installed at the bottom of a vertical run, in which case they shall be raintight and designed to drain. They shall be placed not less than six above final grade.

504. Service Entrance Conduit

Aluminum conduit shall not be used under the following conditions:

- A. When bare copper conductors are used.
- B. For mast type construction.
- C. In contact with the earth.

Rigid non metallic sunlight resistant conduit recognized for use above ground may be used as permitted by NEC Article 352, with the following added restrictions:

A. It shall **not** be used in **mast type services**.

(See paragraph 505, below.)

B. **Only** schedule 80 may be used at locations which are subject to physical damage (per the NEC).

505. Service Mast Construction

Unless otherwise approved by the company, masts shall be constructed of rigid steel conduit or steel intermediate metal conduit (IMC) with an inside diameter of no less than 2. Refer to illustration number 3 in Section XII.

Aluminum conduit, rigid non metallic conduit or electrical metallic tubing (EMT) shall not be used for masts.

Because the mast is grounded through the meter socket hub, it should **not** be bonded to the **neutral** (grounded conductor) at the top end.

VI. SERVICE (ENTRANCE) EQUIPMENT

600. Disconnecting Means/Emergency Disconnect

A suitable service disconnecting means must be provided for each customer's source of supply. In multiple occupancy buildings a main service disconnecting means, as required by the NEC shall also be installed so as to completely disconnect all of the interior wiring at one point. In accordance with NEC Section 230.71, there shall be not more than six disconnects (without a main), per service, grouped in any one location. Each service disconnect shall be permanently marked to identify it as a service disconnect. The disconnecting means must be located in a readily accessible place either outside of a building or structure or inside nearest the point of entrance of the service conductors (per NEC Section 230.70 and Section 230.85). The disconnecting means shall plainly indicate whether it is in the open (OFF) or closed (ON) position per NEC Section 230.77. Where a circuit breaker is utilized and the handle is operated vertically, the "up" position shall be the "on" position (per NEC Section 240.81).

The service equipment for permanent services shall be of a type and size as required by NEC Article 230 and shall be marked "suitable for use as service equipment" per NEC Section 230.66. The company reserves the right to seal any service disconnecting means as a general safety measure and as a protection against tampering by unauthorized persons. The company will not be responsible for sizing service equipment.

It is the customers responsibility to ensure that service entrance equipment conforms to NEC 110.9 and NEC 110.10.

Mounting provisions for service disconnecting means and associated equipment shall be furnished and installed by the customer. They shall solidly support the equipment and provide anchorage for cables and conduits attached to the service equipment. Where located in basements, an air space shall be provided at the back when next to an outside wall. They shall be of sufficient size to readily accommodate the equipment to be mounted upon them. All layouts in multiple occupancy buildings shall be subject to approval by the company.

601. Sequence of Disconnecting Means and Meter Equipment

A. 120/240, 120/208 AND TRANSFORMER-RATED SERVICES

The location of the service disconnecting means shall be on the load

side of the metering equipment (meter switch fuse sequence, i.e., metered “hot sequence”).

Exception #1: On the Portland downtown network and other similar urban underground systems, the sequence shall be switch fuse meter.

Exception #2: In multiple meter locations where the NEC requires a main disconnect, the sequences shall be main disconnect meter switch fuse.

Exception #3: The company may allow a switch fuse meter sequence in switchboards and switchgear. Prior company approval is required.

Exception #4: When N.F.P.A regulations require fire alarm systems to be tapped onto the line side of the main disconnect, then the metering shall be on the line side of all disconnecting means (meter fire alarm switch fuse sequence).

B. 277/480 AND 240/480 SELF CONTAINED SERVICES

The location of the disconnecting means shall be on the **line side** of the metering equipment (switch fuse-meter sequence, i.e., metered “cold sequence”).

C. GENERAL

The contractor shall be required to furnish and install multiple conductor terminal lugs of the correct size when necessary.

Neutral isolation metering may be required for cold sequence designs. Only an accessory neutral isolation kit from the manufacturer of the metering equipment shall be used. Neutral wire may not pass straight through the metering equipment, nor will inline splices be accepted.

602. Metered and Unmetered Wires

All unmetered wires, except those used as service entrance conductors in cable, shall be run in steel or aluminum conduit, electrical metallic tubing, standardized metal troughs or suitable rigid non metallic conduit as permitted by the NEC.

Metered and unmetered wires shall not be run in the same conduit, raceway or gutter. Exception: where the meter is pole mounted and the service is to pole mounted communications and television equipment, both sets of wires may be installed in a single vertical conduit run. Refer to illustration number 6, CATV Power Supply Installation, in

Section XII. Coded conductors should always be used for positive identification.

603. Emergency or Standby Power

Where a customer makes provisions for or installs an emergency or standby source of electric service, **whether permanently mounted or portable**, which is designed to energize the normal wiring system **at the service entrance**, the customer shall notify the company in advance by calling 800.750.4000 (for Residential) or 800.565.3181 (for Commercial & Industrial). No electrical connection shall be made to the service entrance conductors or equipment until approved by the company. **All installations must comply with the applicable sections of the NEC.** See NEC Article 700 “Emergency Systems” (legally required), 701 “Legally Required Standby Systems”, or 702 “Optional Standby Systems” (permanent or portable). Exception, the State of Maine amended the NEC 702.4(B)(2)(A) as follows:

For optional standby systems that supply single-family dwellings, the standby source shall not be required to be capable of supplying the full load that is transferred by the automatic transfer equipment.

A positive acting “listed” (by UL or other organization acceptable to the “authority having jurisdiction”) double throw switch or other transfer device which meets all of the following requirements shall be used.

- A.** When service is transferred, it must be so arranged as to open all ungrounded conductors from the normal supply from the company before any connection is made to the emergency or standby supply.
- B.** The double-throw switch or transfer device must be so constructed and connected as to positively prevent any possibility of power from the customer’s emergency source feeding back into the company’s distribution system.
- C.** A sign/label shall be placed at the service entrance equipment (as prescribed by the NEC) indicating the type and location of the on site emergency or standby power sources. CMP requires this sign/label be placed conspicuously outside of the building on the service entrance equipment or meter enclosure.

When it is desired to energize all of the customer’s distribution circuits from the emergency or standby source, the above switch may, if acceptable to the “authority having jurisdiction,” be connected on the line side of the regular service disconnecting means; provided, in accordance with the NEC, the equipment is

marked as “suitable for use as service equipment” and is installed per its “listing.” Additionally, for the case of automatic transfer, there must be a manual disconnecting means (suitable for use as service equipment) on the line (CMP) side of the auto-transfer device. This disconnect may be an integral part of the transfer device. Where equipment is exposed to the weather, it must be of a raintight construction.

Conductors that may be energized by emergency or standby generating equipment shall not be located in the same conduit or raceway as service entrance conductors from the company’s system.

When the emergency or standby generator is arranged to serve only specific equipment by use of separate circuits that are not connected to the normal wiring system, a main transfer switch will not be required.

In accordance with NEC Section 702.5(A) (Exception), “Temporary connection of a portable generator without transfer equipment shall be permitted where conditions of maintenance and supervision ensure that **only qualified persons service the installation** and where the normal supply is physically isolated by a lockable disconnect means or by disconnection of the normal supply conductors.”

604. Changes In The Service Entrance

Any expenses in connection with the relocation or change of company facilities as a result of a customer change or relocation of the service entrance shall be borne by the customer.

605. Standards of Certification of Generators and Interconnection Equipment

To qualify as “certified” for any interconnection procedures, generators shall comply with the following codes and standards as:

1. IEEE 1547 Standard for Interconnecting Distributed Resources with Electric Power Systems; and
2. UL 1741 Inverters, Converters and Controllers for Use in Independent Power Systems.

VII. GROUNDING AND BONDING

700. General

Service entrance grounding must be in compliance with the NEC and all applicable municipal and State requirements. NEC Section 250.4 covers the “General Requirements for Grounding and Bonding.”

A grounded electrical system shall have its neutral connected to **earth** in a manner that will limit voltage imposed by lightning or line surges; as well as stabilize the voltage during normal operation. Electrical enclosures and other electrically conductive material likely to become energized shall be installed in a manner that creates an **effective ground-fault current path**; as defined in NEC 250.2, “an intentionally constructed, permanent, low-impedance electrically conductive path designed and intended to carry current, underground-fault conditions, from the point of a ground fault on a wiring system to the electrical supply source...”

In accordance with NEC Section 250.24, any grounded ac system operating at less than 1,000 volts, shall have the grounded conductor (neutral) run to each service disconnecting means and bonded to each disconnecting means enclosure or assembly. Additionally, the neutral (for a grounded system) and service equipment enclosures (for a grounded or ungrounded system) shall be bonded together and connected by a grounding electrode conductor to the grounding electrode system. Connection of the grounding electrode conductor to the service neutral may be made at any accessible point from the **load end** of the service drop or service lateral to, and including, the neutral terminal or bus at the service disconnecting means. This connection is normally made to the service entrance panel neutral bus or meter enclosure neutral/ground lug, whichever will result in the shortest grounding electrode conductor and is acceptable to the “authority having jurisdiction.”

701. Grounding Electrode System

The grounding electrode system shall be in accordance with NEC Section 250-III.

For much of Central Maine Power company’s service territory, meeting the “25 ohms or less” requirement is highly unlikely; therefore, installation of an additional electrode is required. **It is the responsibility of the customer/electrician to verify the 25 ohms, or less, resistance to be exempt from this requirement.**

702. Bonding

To prevent any potential differences from occurring between them, all of the grounding electrodes listed in paragraph 701, as well as CATV, communications or any other system grounding electrodes that are available on the premises, shall be bonded together. Intersystem bonding shall be installed in accordance with NEC 250.94 and shall have the capacity for at least 3 intersystem bonding conductors.

It is the responsibility of the customer/electrician to ensure intersystem bonding provisions are provided. In the case where the grounding electrode/conductor or metallic conduit is not accessible, a UL listed meter box ground clamp may be installed; provided it is not attached to, nor does it interfere with operation of, the meter enclosure cover. Any metal piping system installed in, or attached to, a building or structure; and any steel building frame shall be bonded in accordance with NEC Section 250.104.

Bonding on the line side of the service overcurrent device must be “ensured.” Metal conduit and enclosures containing service conductors shall be effectively bonded together in accordance with the requirements of NEC Section 250.92. Suitable bonding methods include but are not limited to: threaded couplings and hubs, listed bushings with bonding jumpers, and listed bonding-type locknuts. Bonding jumpers shall be used around concentric or eccentric knockouts. Standard locknuts or bushings shall not be the sole means for the bonding required for services. All bonding jumpers (intended to conduct fault current), on the line side of the service overcurrent device, shall be sized in accordance with NEC Section 250.102 (C); i.e., sized to NEC Table 250.66, the same as, grounding electrode conductors.

Bonding is effective as a means to prevent or mitigate problems due to the phenomenon commonly called stray voltage. The company recommends that provisions be made to bond any steel reinforcing mesh or rod to the electrical grounding system whenever any concrete slabs are poured. This is particularly important for dairy barns and houses constructed on concrete slab foundations. **Refer to NEC Section 547.10 for information regarding bonding and equipotential planes in agricultural buildings.**

It is recommended that, whenever work is in progress on any premises, contractors inspect the condition of all grounds and bonds and call the owner’s attention to any which may be broken or missing. The connection to a metal underground water system shall be on the street side of the water meter, if practical, otherwise bonds shall be placed

around all parts which may be disconnected, between the point of attachment and the street side of the water meter.

703. Grounding Electrode Conductor

The grounding electrode conductor shall always be rigidly supported, protected from physical damage and be securely attached to the grounding electrode with a cast metal clamp or other device listed for the material of the grounding electrode and grounding electrode conductor (See NEC Section 250.70 for further details).

The grounding electrode conductor attachment (to a ground rod) must be flush with or below ground level or otherwise protected against physical damage as specified in NEC Section 250.10.

The size of the conductor must meet the minimum requirements of NEC Section 250.66. **For additional protection of electronic equipment, it is recommended that the grounding electrode conductor be no smaller than No. 4 AWG, stranded, copper and be as short as possible.** Refer to IEEE Standard 1100 (Emerald Book) for the Recommended Practice for Powering and Grounding Sensitive Electronic Equipment.

Whenever connection of the grounding electrode conductor is made in the self-contained meter enclosure, it must be connected to the grounded service conductor (neutral) per NEC Section 250.24 (A). The enclosure itself shall not be part of the grounding electrode conductor.

Whenever connection of the grounding electrode conductor is made in the self-contained meter enclosure, it must be “connected to the grounded service conductor (neutral)” per NEC Section 250.24(A). The enclosure itself shall not be part of the grounding electrode conductor per NEC Sections 250.62 and 250.64.

704. Lightning Protection System

In accordance with NEC Section 250.106, lightning protection system ground terminals (rods) shall be bonded to the building or structure grounding electrode system. All grounding electrodes shall be bonded together. Electric equipment metal raceways and enclosures should be bonded to lightning protection conductors or separated from lightning protection conductors in accordance with the “Standard for the Installation of Lightning Protection System,” NFPA 780. Separation from lightning protection conductors is typically 72 through air or 36 through wood or masonry. The ground connection from a television antenna for the purpose of lightning protection should be treated the same as a lightning rod ground.

705. Service Surge Protection

Protection from lightning or power surges at the service entrance is the responsibility of the customer. We are not liable for damages resulting from lightning, power surges or other forces beyond CMP's control, such as unplanned service interruptions. Although the state of Maine did not adopt NEC 230.67, CMP strongly recommends installers comply with NEC 230.67 to limit customer liability. These devices shall not be installed in or on the meter enclosure or on the line side of any metering equipment, unless they are company owned and maintained.

VIII. METERING EQUIPMENT

800. General

The customer shall furnish and install company approved meter mounting devices, including outdoor enclosures, instrument transformer cabinets and indoor test or connection block cabinets in accordance with the requirements in this handbook and NEC Article 312. Refer to the "Supplement" for meter mounting equipment requirements and options (see inside back cover of this handbook). All such enclosures must be sealable with padlock type seals and such **seals shall be removed only by qualified company employees.**

All metallic equipment used for metering purposes shall be properly bonded and grounded as required by Section VII and the applicable illustration in Section XII of this handbook, and NEC Article 250. For services with instrument transformer-rated metering, an overall meter enclosure as approved by the company is generally required. See illustration numbers 14, 15, 16, and 17 in Section XII.

A meter socket (enclosure) shall be permanently and solidly mounted before the meter will be installed. All outside meter enclosures must be secured by screws, #12 minimum, which are stainless steel or zinc, or cadmium coated (no washers allowed).

Whenever practicable, all electricity sold (delivered) to one customer on one billing will be measured (metered) at one point. Furthermore, the metering should be located at, or near, the point of delivery and at delivery voltage whenever it is practicable to do so.

The company will furnish and install all meters. When required, current transformers (CTs), voltage transformers (VTs), test switches and control cable for installation in the customer's approved equipment will be furnished by the company.

Whenever practicable, all electricity sold (delivered) to **one customer on one billing** will be measured (metered) at **one point.**" Furthermore, the metering should be located at, or near, the point of delivery and at delivery voltage whenever it is practicable to do so.

The customer shall make reasonable effort to separate residential and non-residential use for metering purposes.

801. Metering Multi-Tenant Buildings

A. RESIDENTIAL SERVICE

As a general rule, in accordance with the Public Utility Regulatory Policies Act of 1978 (PURPA), each dwelling unit in a building that contains more than one residential dwelling unit will be separately metered.

If the building is master metered, then for residential rate application, there shall be no three-phase load on the residential master meter; however, the service to the building and the residential master meter itself may be three-phase.

Each multi-tenant dwelling a meter and a house meter will be required when services are changed to meet all codes or installed the first time.

B. GENERAL (NON-RESIDENTIAL) SERVICE

As a general rule, in accordance with PURPA, each separately leased or owned unit in a building that contains more than one non-residential (commercial) unit will be separately metered.

802. Meter Location

The location of all metering equipment must be approved by the company **prior to installation**. Meters shall be installed in safe and readily accessible outdoor locations when such a location is available. Neither meters nor enclosures shall be attached to padmount transformers or fences.

Meters shall be located outdoors. Express permission must be obtained prior to installation of indoor metering equipment. Whenever it is necessary to install meters indoors, the location shall be chosen with regard to safety, accessibility for reading and maintenance. The meter shall be installed on the ground floor. In certain cases, they may be installed in groups, in rooms reserved for this purpose on other floors. See CMP metering construction standards for complete details. Unmetered conductors supplying meters in separate meter rooms shall be installed in separate **metallic** conduit. Meters shall not be installed in storage rooms, cabinets, closets, or other locations that may be locked or otherwise made inaccessible.

803. Meter Position

All meter mounting devices shall be installed so that the meters will be upright (plumb). They shall be installed with the top of the

meter not less than 48 or more than 60 from the floor or final grade. Exceptions to this height requirement are for installation of group or modular metering (see illustration number 12 in Section XII), and transformer-rated overall meter enclosures (see illustration numbers 14, 15, 16, or 17 in Section XII).

Level grade shall be maintained for a minimum of 36-inches in front of the meter enclosure to provide a safe working space. In order to meet this requirement on uneven terrain, as an option, the customer may install a pressure treated wood platform. For modular metering, see illustration number 12 in Section XII.

804. Pole Mounted Meters

Pole mounted meters shall, generally, be installed on a **customer owned** service/meter pole, as previously indicated in paragraph 404. Refer to illustration number 4 (single meter) or 5 (multiple meter) in Section XII for construction details.

All pole mounted meter enclosures **shall be grounded to a ground rod at the base of the pole**. If a ground rod is already in place for grounding other equipment on the pole, a connection shall be made to it, otherwise a "supplementary" ground rod (5/8" x 8' min.) shall be installed for this purpose by the customer/electrician.

When a service disconnect is installed on a pole, the grounding must meet all requirements of Section VII of this handbook and NEC Article 250 for service entrance grounding.

The installation of a meter on a company pole requires advance approval by the **company** and will only be allowed in special cases such as for CATV power supplies (See illustration number 6 in Section XII). The installation shall be made to minimize interference with climbing space, and conductors shall be enclosed in metallic conduit. Schedule 40 or 80 PVC may be used above the meter.

805. Meter Pedestals

Meter pedestals used with underground services for the exclusive use of electric metering and communication circuits must be approved in advance by the company. Metering of gas, oil, and other services will not be permitted except by remote meter register. Although a disconnect and overcurrent device (on the meter pedestal) may not be required (by the NEC) for commercial applications, it is highly recommended since it provides protection for the customer's cable and allows the customer to disconnect and maintain their conductors

without the cost of a company line crew visit. Refer to illustration numbers 9 and 11 in Section XII for details of a pedestal service.

All pedestal mounted meter enclosures **shall be grounded** (at a minimum) to a “supplementary” ground rod (5/8” x 8’ min.) installed by the customer/electrician. If a service disconnect is installed, then the grounding must meet all requirements of Section VII of this handbook and NEC Article 250 for service entrance grounding.

A company approved prewired combination meter socket and service disconnect pedestal may be used. It must include a stabilizing means to extend below the frost line (to a minimum of 48” below finished grade). The meter pedestal must be installed so that the top of the meter will not be more than 60 or less than 48-inches above the finished grade or ground line. Metered and unmetered conductors shall not be run in the same raceway or gutter. Refer to the “Supplement” for prewired pedestal requirements (see inside back cover of this handbook). Refer to paragraphs 408 and 409 of this handbook for service requirements to mobile homes, manufactured homes, and travel trailers.

806. Multiconnection Points

Single terminals of meter sockets, or meter connection blocks, shall not be used as connection points for more than one conductor. Where multiple conductors are used, suitable terminal lugs that comply with the NEC and are acceptable to the company shall be furnished and installed by the contractor. Stud type terminals are generally required to accommodate double (twin) lug arrangements. Refer to the “Supplement” for meter mounting equipment options (see inside back cover of this handbook).

807. Identification of Meters

Wherever there is more than one meter installed on any one premise, it shall be the Customers’ responsibility to clearly identify the area served by each meter. Each room or apartment number, floor or other area, shall be neatly and plainly marked on the service equipment and, if the meter and disconnect are not a single unit, on the inside and outside of the meter enclosure (not on the cover) with paint or permanent marker. The customer shall notify the company of any changes. Other identifications, such as street address and service classifications (light, heat or power) when not readily obvious, shall also be provided. For sequence in multiple meter installations, see illustration number 12 in Section XII.

808. Clearance For Metering Equipment

Not less than 36-inches of clear, unobstructed working space free of poisonous vegetation shall be provided and maintained under and in front of all metering equipment in accordance with NEC Section 110.26. In the case of unguarded moving machinery, changes in floor level, uneven terrain, etc., a clearance of 72-inches shall be provided in front of all meters. A clearance of at least 6-inches shall be provided between the nearest obstruction above and on each side of any single meter or group of meters.

In case space is limited where meters are mounted in a group, special layouts shall be obtained from the company before proceeding with the installation of equipment. Sufficient clearance shall be provided in choosing the location of all metering equipment so that the doors of all cabinets and switches can be completely opened. For clearance requirements in multiple meter installations, see illustration number 12 in Section XII.

The National gas codes and standards (NFPA-54, NFPA-58 and 49 CFR 192) cover the requirements for gas equipment clearances. **When locating or relocating electric service equipment, where gas equipment has already been installed, the following guidelines should be used** to ensure compliance with the minimum separation required between the electric meter or combination meter/disconnect (ignition sources) and **any gas relief valve, vent discharge, filling connection, or regulator vent:**

GAS CONTAINER/SYSTEM TYPE	MINIMUM SEPARATION
Propane tank (exchanged)	5-feet
Propane tank (filled on-site)	10-feet
Propane regulators	5-feet
Natural gas (piped) vented equipment	5-feet

809. Self Contained Metering

A. GENERAL

Self contained meters shall generally be used for the following services:

Single-Phase:

VOLTS	MAX AMPS	WIRE
120	60	2 (3-wire meter)
120/240	400	3
240/480	200	3
120/208	200	3 (network meter)

Polyphase:

VOLTS	MAX AMPS	WIRE
120/208	400	4 (4-wire wye)
277/480	200	4 (4-wire wye)

Refer to illustration number 13 in Section XII for self contained meter socket connections.

For underground **residential** service installations, meter sockets for use with #4/0 or larger service cable shall be of the “side wired” (or otherwise wired out away from the meter line side terminals) underground type. For **non-residential** underground application and for “continuous conduit systems,” the “side-wired” socket is not required; however, it is highly recommended since the meter socket base is less likely to be damaged by frost action. Refer to the “Supplement” for meter socket requirements and options (see inside back cover of this handbook).

B. METER BY-PASS REQUIREMENTS

A **Residential*** 100, 125, 150 or 200 amp socket does not require a bypass; however, a single handle lever operated by-pass is permitted. Since it allows for testing and changing out of the meter without interrupting service, a lever operated **by-pass is recommended** wherever minimization of possible interruption of service, during normal business hours is important, such as in the case of a home office or certain community/house loads.

A single hand lever operated **by-pass is highly recommended** for residential locations with pump operated septic/sewer systems.

*Note: The following types of services are considered by the company to be “residential” use:

- Any dwelling unit, garage, storage building, shelter/gazebo, water pump, or other structure or equipment that is used solely

for private (non-business) purposes.

A Residential 320 amp socket requires a single handle lever operated by-pass which locks the meter blades in the socket jaws.

A **Non-residential** (Industrial or Commercial) self-contained meter socket **requires a by-pass** as follows:

METER SOCKET	BY-PASS
Single-phase:	
100, 125 or 150 amp	**Single handle lever operated by-pass required.
200 amp	**Single handle lever operated by-pass which locks the meter blades in the socket jaws required.
320 amp	Single handle lever operated by-pass which locks the meter blades in the socket jaws required.

** The reason for the by-pass requirement is to enable the company to test or change-out the meter without causing an interruption of service. The clamp jaw type by-pass has the additional benefit of insuring a good electrical connection between the meter blades and socket jaws, thereby preventing loose (HOT) socket. The by-pass is particularly important for use during the company’s normal business hours. Therefore, the following types of **non-residential** services (200A or less) are **exempt** from these by-pass requirements and the residential socket (non by-pass) may be utilized:

- Temporary service.
- Outdoor lighting (ball field, tennis court, etc.)
- CATV or Telephone power supply/amplifier.
- Any other non-residential facility that is **not** “in use” during the company’s normal business hours.

Note: a **by-pass is required** for traffic signal light power supply services.

Three-Phase:

METER SOCKET	BY-PASS
100 or 125 amp	Single handle lever operated bypass required.
200 or 320 amp	Single handle lever operated by-pass which locks the meter blades in the socket jaws required.

Refer to the “Supplement” for more details on meter socket and by-pass requirements (see inside back cover of this handbook).

810. Instrument Transformer Metering

A. CURRENT TRANSFORMERS (CTs)

The following services shall be arranged for metering with CTs only (no VTs):

Single-Phase:

VOLTS	AMPS	WIRE
120/240	greater than 400	3

Polyphase:

METER SOCKET	BY-PASS	WIRE
120/208	greater than 400	4 (4-wire wye)
120/240	greater than 400	4 (4-wire delta)
240	greater than 200	3

B. CURRENT AND VOLTAGE TRANSFORMERS (CTs & VTs)

Installations (except for “self contained”, paragraph 809) where the voltage of the incoming line is greater than 150 volts to ground (on a grounded line) or greater than 300 volts between conductors (on an ungrounded line) shall generally be arranged for metering with both CTs and VTs.

NOTE: With prior company approval, 277/480 volt, greater than 200 amp, four-wire wye services may be arranged for CTs only (no VTs) metering.

Customers will not be allowed to connect any equipment to the metering terminals of instrument transformers.

C. METER MOUNTING DEVICES (TRANSFORMER-RATED)

The customer shall supply and install all meter mounting devices as required. Refer to the “Supplement” for meter mounting equipment requirements and options (see inside back cover of this handbook). All transformer-rated meter mounting devices shall have provisions for mounting a test switch.

Meter mounting devices shall be properly bonded and grounded, by the customer, in accordance with Section VII, “Grounding” and

NEC Article 250. This generally requires connection to a grounding electrode with a grounding electrode conductor no smaller than No. 4, stranded copper. Additionally, there must be appropriate bonding to provide an effective ground-fault current path to the (voltage) source neutral. See illustration numbers 14, 15, 16, or 17 in Section XII for further details.

Meter mounting devices shall be located as near as possible to the instrument transformers at a location approved by the company. They must not be located in vaults. Advance company approval is required for any metering conduit runs in excess of 35-feet.

In the case of primary metering, where the meter enclosure is to be mounted on a pole, the customer shall furnish and install at their own expense the 1-¼-inch conduit between the instrument transformers on the pole and the meter mounting equipment.

Where danger of plow or traffic damage exists, barriers consisting of concrete filled 6-inch IPS steel posts set a minimum of 48-inches deep must be installed for protection of the meter/meter mounting equipment. The posts shall be located so as not to interfere with the opening of doors/covers or restrict access to enclosures.

811. Instrument Transformer Cabinets

For installations where the service voltage does not exceed 480 volts, cabinets for instrument transformers shall be furnished by the customer and be constructed and installed so as to meet the requirements of NEC Article 312. See illustration number 14 in Section XII for instrument transformer cabinet installation details. Cabinet size will be as specified by the company. Refer to the “Supplement” for cabinet sizing requirements and options (see inside back cover of this handbook).

All cabinets shall be constructed so that the cover can be readily opened. The cover shall be attached with hinges. The cabinet must be mounted so that the cover does not interfere with installation or maintenance work. For outdoor locations, cabinets shall be weatherproof or rain tight.

Provision must be made so that the cabinet can be securely sealed with a padlock type seal when the cover is closed. Only company owned devices may be installed in any cabinets housing meter connection devices or instrument transformers.

All line conductors, including the neutral, shall pass through the instrument transformer cabinet. In addition, all line conductors in the

cabinet must be clearly identified (by the customer/electrician), as to, “phase” and “line” or “load.” A neutral connector shall be installed by the customer to provide for connection of the metering neutral. The customer shall mount all instrument transformers and make all primary connections. Secondary (metering) wires are furnished and installed by the company.

A separate 1-¼-inch minimum **metallic** conduit with a pull line for metering wires between instrument transformer cabinets and meter mounting devices shall be furnished and installed by the customer. This conduit shall be either rigid metal conduit (RMC) or intermediate metal conduit (IMC) and be properly bonded to provide an effective ground-fault current path (per Section VII and NEC Article 250). Advance approval must be obtained from the company for special construction before installing conduit runs in excess of 35-feet. Conduit fittings with removable covers (LBs, CS, etc.) shall only be used at the CT compartment and at the meter provision, with no more than two of these fittings per installation. The maximum height for fittings with removable covers is eight-feet.

Where danger of plow or traffic damage exists, barriers consisting of concrete filled 6-inch IPS steel posts set a minimum of 48-inches deep must be installed for protection of the meter/meter mounting equipment. The posts shall be located so as not to interfere with the opening of doors/covers or restrict access to enclosures.

For locations where the service voltage exceeds 480 volts, advance company approval of the instrument transformer installation is required. See paragraph 814 for Switchgear Installations.

812. Mast or Building Mounted CT Installation

Mounting of CTs/VTs on the customer’s service mast or on the building adjacent to the weatherhead is not permitted.

Note: Except for the case of primary metering, CTs shall **not** be mounted on poles or pole mounted brackets.

813. Padmount Transformer Installations

Provided there will be only **one customer** served from the padmount transformer, the CTs may be mounted inside the padmount transformer enclosure. VTs shall not be installed in the padmount transformer enclosure. The VTs may, with prior company approval, be installed in a separate weatherproof cabinet adjacent to the meter enclosure. CTs shall not be installed inside single-phase padmount transformers.

814. Switchboard/Switchgear Installations

When instrument transformers are to be installed in switchboard or switchgear, advance company approval of transformer compartment plans is required. CMP requirements for switchboard or switchgear installations will be provided to Developers upon request.

When other metering options are available, CMP discourages the use of switchboard metering but is willing to review proposals provided that the incident energy level at utility compartment is less than 20 calories/cm². The customer will identify to the meter engineer why the specific metering equipment is needed and is the best option in advance of purchasing and commencing construction with the proposed equipment.

IX. UNDERGROUND SERVICE

900. General

The company will, subject to the availability of material and transformers, and in compliance with certain special requirements hereinafter described, provide underground service directly from its distribution lines.

For added protection and ease of cable replacement, the company strongly recommends that all underground cables be installed in conduit. Any direct buried primary cable shall not be permitted within five (5)-feet of the traveled way. Contact the company's local Service Center for conduit installation details not contained in this handbook.

All installations connected to company owned facilities shall comply with the installation specifications contained herein. These requirements are based on the NESC or NEC and considered to be good engineering practice.

The illustrations in Section XII of this handbook provide the required trench, riser and transformer foundation details.

Direct-buried conductors and cables emerging from grade shall be protected from damage in accordance with NEC 300.5(D).

Any work listed as being the "responsibility" of the customer means that the customer will be required to complete the work involved to meet company standards and specifications. **All work performed by the customer shall be subject to inspection by the company prior to energizing the installation.**

901. Customer Responsibility

It shall be the customer's responsibility to:

- Notify **DIG SAFE at 811 or digsafecom.com** prior to any excavation.
- Make arrangements for the installations by other utilities.
- Provide the trench excavation, back fill and all conduit installation in accordance with this handbook section (IX). (See paragraph 910 for conduit requirements/specifications.)
- Provide and install a transformer pad(s) and primary junction box (es) meeting the company's specifications as outlined in illustration numbers 22, 23, 24, 25, 26, and 34 in Section XII. Pad designs must conform to company specifications to ensure interchangeability with spare transformers.

- Provide the necessary permanent easements and permits (including environmental) to cover the location of the company's facilities including aerial lines, underground cable and equipment and transformers. This includes municipal and State permits for conduit under the public way.
- Keep the route of any underground cable clear of structures, bushes, or trees.
- Pay any additional expenses the company incurs as a result of severe weather conditions or frost in the ground during underground construction between November 1 and April 1. This charge will be in addition to all other costs.

902. Company Responsibility

It shall be the company's responsibility to:

- Provide specifications for the underground service.
- Approve all layouts for underground service.
- Furnish and install (at the customer's expense) the primary cable in conduit furnished by the customer or direct buried.
- Provide a padmount transformer of adequate capacity.

903. Customer Costs

The customer shall pay for all costs for the installation of single-phase secondary underground (UG) service.

Should it be necessary for the company to install a road crossing pole specifically for an underground service installation which would not be provided for an equivalent overhead service, the customer shall be assessed a fee to cover the additional cost.

The payment for the underground construction costs must be received by the company prior to the scheduling of the construction.

904. Loop Feed Requirement

When providing primary underground service to be owned by the company or located in a public way, the construction will be a Loop Feed System or contain a spare cable. A primary underground line feeding a single customer and owned by that customer may be constructed as a radial feed system. See paragraph 219 of this handbook for more information on customer constructed/owned lines.

A Loop Feed system is required when multiple pad mount transformers

are being served. A Loop Feed System serves loads from one source circuit, through two separate cables or sets of cables. Ideally, the risers would be on separate poles, but when economic or physical conditions prevent the utilization of two separate poles, it shall be acceptable to mount the riser(s) on a common pole. Loop Feed Systems shall be from the same phase of the same circuit. If this is not possible, written approval from the company shall be required for a Loop Feed System fed from different phases or circuits. A spare cable may be used in certain applications in polyphase construction and requires the installation of an additional primary cable in a common conduit with a spare adjacent conduit. The use of a spare cable versus a Loop Feed System will be at the company's discretion and shall be determined prior to the design phase of the construction project.

An Alternate Feed System involves two distinctly separate feeds, in separate conduit systems, and from separate circuits. This type of system is designed to be operated primarily from one of the sources, with the other source being for emergency or back-up purposes. Alternate Feed Systems shall require the written approval of the company.

905. Residential Secondary Services

Residential underground services to operate below 150 volts to ground may be installed in customer owned conduit or direct buried in trench provided by the customer and meeting company standards and specifications as outlined in illustration numbers 30, 8, 9, 10, 11, 31 and 33 in Section XII.

The cable is furnished and installed **by the customer**, particular notice should be made of the maintenance provisions of paragraph 916. The maximum length of customer owned residential underground secondary shall be in accordance with illustration number 31 in Section XII. For services or conductor sizes other than those listed in illustration number 31, contact the company's local Service Coordinator. Where service runs exceed the lengths listed in illustration number 31 in Section XII, or become impractical, a primary underground feed to a padmount transformer will be required.

There shall not be more than eight (8) conductors per spade for a three-phase padmount. There shall not be more than six (6) conductors per spade for a single-phase padmount. Cases involving more conductors than these limits must be referred to the company for special design and prior approval.

The company will make all connections to padmount transformers.

However, on customer owned cable, the customer must provide all lugs and associated hardware and install them on the cable.

For any underground service, splices or taps should be avoided. If splices or taps (as permitted in NEC Section 230.33 and 230.46) are required, then they must be in an enclosure, or, direct buried using a splice "listed" for direct burial and for the cable type used. Any splices on CMP's side of the meter socket must be accessible for inspection (by CMP). Note, by choosing the appropriate meter socket, splicing for the purpose of "downsizing" conductors may be avoided (refer to the "Supplement," paragraph 1.10.5).

906. Non-Residential Secondary Services

All underground secondary cable (including transformer interconnecting cables) and terminal lugs required must be provided and owned by the customer whether from overhead or padmount transformer installations. Except as noted in paragraph 914, "Risers", cable will be installed by the customer.

Three-phase service from a **pole mounted** three-phase unit or banked arrangement of transformers may be provided for total switch(s) capacity not to exceed 1,000 amperes. Note: Overhead secondary will be limited to two-four conductor (three-phase conductors and one neutral/messenger) cables 336.4 kcmil (or smaller). Underground secondaries consisting of cables with conductors 4/0 AWG and smaller shall have no more than four conductors per phase. Underground secondaries consisting of cables with conductors larger than 4/0 AWG shall have no more than two conductors per phase. The owner of the secondary cables shall provide all terminal lugs and transformer secondary interconnecting cable and connectors. Cable support and positioning brackets may be required at the discretion of the company's local Line Supervisor. If required, the support and positioning brackets shall be provided by the cable owner.

There shall not be more than eight (8) conductors per spade for a three-phase padmount. There shall not be more than six (6) conductors per spade for a single-phase padmount. Cases involving more conductors than these limits must be referred to the company for special design and prior approval.

Cases involving more than one customer per transformer or exceeding the above number of conductors per phase must be referred to the company for special design. Secondary connections to padmount and vault transformers are to be coordinated with the local Service Coordinator; normally the customer (contractor) will terminate the

cables, position and support the cables to minimize the weight load on the transformer bushings and assemble all connectors on the transformer bushings.

Where multiple customers are supplied from one transformer, each service must be properly identified. The neutral conductor must be properly identified. See paragraph 501 of this handbook and Section 200.6 of the NEC.

All highway lighting secondary underground circuits shall be installed in galvanized steel or heavy-wall non-metallic conduit (Schedule 40 minimum).

907. Underground Residential Distribution (URD) Developments

The company will provide an underground distribution system in a residential development where: (1) such system is requested by a builder or developer who meets the requirements outlined herein, (2) where soil and terrain conditions, in the opinion of the company, would permit such a system, and (3) no other distribution system exists or will be required in the future which would result in duplication of facilities.

The development shall be laid out in such manner that there will be a continuous distribution system to the most remote location requiring service.

Transformer pads will generally be located adjacent to the property line and between ten and twenty-feet in from the street lines in accordance with illustration number 21 in Section XII.

Construction of the URD system will not normally be undertaken until all grading is completed and services which are installed at a lower grade (sewer, water, gas) are already in place. Electric service will not normally be installed in advance of the requirement for use.

A. RESPONSIBILITY OF THE COMPANY

The company will:

- Determine the location and provide specifications for the underground electrical distribution system, including primary and secondary circuits, transformers and customer services.

B. RESPONSIBILITY OF BUILDER, DEVELOPER, OR CUSTOMER

For a URD system, as described herein, the builder or developer will:

- Furnish to the company a **complete site plan** of the

development in electronic form as approved by the municipality; such plan to show the grading, layout and dimensions of lots, sidewalks and curbs, and the location of **all** other utilities and other underground structures.

- Install lot boundary pins or markers in the area under development prior to the start of trenching for the URD.
- Notify the company of the completion of rough grade, installation of other facilities at grades below URD and the schedule of desired electric service connections so that the company will have adequate time to install its facilities.
- Provide trenching and conduit or conduit systems as required. See paragraph 901 for a list of such requirements and paragraph 910 for conduit requirements/specifications.

908. Padmount Transformers

Installation of padmount transformers is limited to cases meeting the following specifications:

1. Single-phase three-wire services, (a) operating at 120/240 volts and requiring transformer capacity of not more than 167 kVA, or (b) operating at 240/480 volts and requiring transformer capacity of not more than 50 kVA; or
2. Three-phase four-wire services operating at 120/208 volts or 277/480 volts Wye and requiring transformer capacity of not more than 2500 kVA. (Larger units may be available by special arrangement.)

In cases not meeting the preceding specifications, the customer shall provide a company approved transformer vault or yard. Additional information will be furnished upon request.

Padmount transformer foundations must be supplied by the Customer and pad designs must conform to company specifications to ensure interchangeability with spare transformers. See illustration numbers 23, 24, 25, and 26 in Section XII.

Padmount transformer locations shall be graded for proper drainage and that drainage shall be maintained by the customer. In addition, the location must be readily accessible by truck at all times without causing site damage.

A ¾-inch by 8-foot galvanized ground rod will be furnished (available at the local Service Center) by the company and installed by the customer. It is to be located 6-inches in front of the left front corner of

the foundation. The ground rod should be left 6-inches exposed above grade until all ground connections are made and inspected. Prior to back filling around the foundation base, the customer will furnish and install a bare #4 stranded copper for grounding of the transformer. The conductor must be of sufficient length **(10 ft. of grounding conductor will be required for single-phase and small (7' x 7') three-phase installations, larger three-phase (9' x 9') or greater will require 20 ft. of grounding conductor)** to connect the transformer neutral and ground to the ground rod. The conductor will extend from the interior of the base, through the ground wire hole (if available) or one of the cable holes (bond outs) in the wall of the base, to the ground rod location. It is NOT to be installed on top of the base or slab (foundation) such that the transformer or slab will bear directly on the conductor.

Where danger of plow or traffic damage exists, barriers consisting of concrete filled 6-inch IPS steel posts set 4-feet deep must be provided for protection (Pressure treated 6 x 6-inch (minimum) timber posts may be substituted in residential areas). The protective posts shall be located so as not to interfere with opening the doors or restrict access to the transformer cabinet. Generally, the posts will be located near the corners of the padmount transformer.

Minimum clearances to buildings and other obstructions (including trees, shrubs and fences) shall be 3-feet from the rear, 5-feet from the sides, and 10-feet from the front of the transformer pad. There shall be no openings in the building wall in back of, beside, or over the transformer, unless the transformer is a minimum of 10-feet from the building. Side clearances from doors or windows shall not be less than 10-feet. Building overhangs that subject the transformer to falling ice and snow shall be a minimum of 10-feet from overhang. There shall be a minimum of 10-feet between the transformer and any gas meter/regulator, gas relief valve, gas vent discharge, gas filling connection, or propane tank. Some insurance companies may require increased clearances.

When padmount transformers are not installed immediately upon the installation of the cable in the transformer pad, the customer/ developer shall provide and install a company approved concrete, steel or fiberglass cover over the pad opening to eliminate exposure of the cable.

909. Industrial and Commercial Primary Installations

The company may provide primary voltage service at 12.47Y/7.2 kV or 34.5Y/19.9 kV up to 200 ampere capacity. Primary service requiring

higher amperage or voltage ratings is beyond the scope of this policy. Information for such service may be obtained by contacting the company's local Service Coordinator.

All industrial and commercial primary 3-phase underground distribution will be installed in a conduit system. The **conduit system** will consist of standard size concrete manholes/handholes as needed to splice joints, junctions, or to meet cable pulling requirements. The ducts will be a minimum of schedule 40 PVC of a diameter adequate for the largest cable that may be necessary to serve the total anticipated load. The conduit system will include an adequate number of ducts for all necessary cables plus one spare duct (capped at both ends) and will provide a loop or alternate feed cable configuration. The conduit will be properly pitched to ensure water drainage into manholes/handholes. Conduit configuration will be limited to a single horizontal layer, if encased in sand. Multiple layer configurations must be encased in concrete. In urban areas or where site conditions make digging for repair of ducts impracticable or cost prohibitive, the conduit system will be encased in concrete regardless of conduit configuration.

The company's Distribution Engineer must approve all conduit layouts prior to construction and will provide the design requirements (number and size of ducts, size and location of manholes and splice boxes) upon request.

910. Conduit Requirements/Specifications

A. GENERAL

The customer shall furnish, install, own and maintain the necessary ducts which must conform to the specifications of the company. The company requires that all primary underground cable serving multiple transformers be installed in conduit.

Galvanized steel conduit or heavy-wall non-metallic conduit (Schedule 40 minimum) shall be used where the ducts are under public streets or ways, paved areas, driveways and all transmission rights-of-way. Where subject to physical damage, non-metallic conduit shall be schedule 80 minimum (per the NEC).

In developments or subdivisions, conduit shall be installed extensively enough to provide a cable raceway under any existing or anticipated street or driveway. In addition, for any buildable lot where the driveway has not been determined by rough grading or curb opening, the conduit shall extend across the entire lot.

Conduit under the public way shall be at least 36-inches below grade and extend at least 48-inches beyond the street limits or paved areas. For State roads, it is the customer/developer's responsibility to comply with the Maine Department of Transportation's Utility Accommodation Policy - Section 10.5 for conduits within the Maine Department of Transportation's right-of-way. Maine DOT currently requires either concrete encased or rigid steel conduit under the roadway, the installation is permitted by the state and rigid steel conduit at least 7' up pole.

Conduit placed under private driveways and walks shall be at least 30-inches below grade and shall extend at least 24-inches beyond the traveled way.

Non-metallic conduit shall be of approved heavy-wall (Schedule 40) design unless encased in a minimum of 3-inches of concrete. All non-metallic conduit used above grade (risers) shall be of sunlight resistant material, and where subject to physical damage, shall be schedule 80 minimum (per the NEC).

Back-fill within 6-inches of conduit shall consist of soil containing no rocks greater than 4-inches in diameter per NESC Section 321 B. During back-filling of the trench, a plastic "ELECTRIC" marker tape (furnished by the company if company owned cable) shall be installed approximately 12-inches below grade (and at least 12-inches above the conduit per NEC Section 300.5).

Upon installation, all ducts shall be clean and free of debris. Any empty ducts shall be capped. An acceptable pull rope must be provided by the customer in all ducts to facilitate the installation of cable. A ¼-inch polypropylene rope, or other line of equal or greater strength, is required.

Conduit installed through a building wall shall have internal and external seals intended to prevent the entrance of gas into the building insofar as practical (NESC 322 B 4).

B. CONTINUOUS CONDUIT SYSTEMS

Continuous conduit runs should not normally exceed 200-feet, with not more than the equivalent of two 90° and one 45° bends (225° total) in the run. Longer runs require engineering review. Multiple layer conduit configurations must be encased in concrete. Conduit will be properly pitched (3" per 100' minimum) for drainage and provisions will be made to allow the conduit to drain. The company may require splice boxes or manholes at the riser pole and in the conduit run for drainage and to facilitate cable installation. Refer

to illustration number 10 in Section XII for Underground Secondary Service Continuous Conduit. Note: To comply with NEC Section 300.5 (J), a conduit slip, or expansion joint shall be provided under the meter socket as shown on illustration number 10 in Section XII. Do not use a combination of PVC and rigid steel conduit for the slip riser. The company will provide design requirements and specifications for other conduit systems.

All 90° bends will be galvanized steel and have the following minimum radii:

CONDUIT SIZE	MINIMUM RADIUS
2"	24"
2-½"	24"
3"	36"
4"	48"
5"	48"
6"	48"

(Two (2) 45° PVC bends shall not be used in lieu of a steel 90° bend.)

911. Direct Burial Primary Cable

Single-phase direct burial primary cable serving a single transformer may be furnished and installed by the company (at the customer's expense) in the customer's trench or duct as provided below. Direct burial cable may be furnished and installed by the customer; however, particular notice should be made of the maintenance provisions of paragraph 916.

Direct burial cable shall be protected for 6-inches above and below by a bedding of soil containing no rocks. The remainder of the back-fill shall consist of clean fill containing no rocks larger than 4-inches in diameter. Bedding and back fill shall be free of roots, stumps and other debris. During back-filling of the trench, a plastic "ELECTRIC" marker tape (furnished by the company if company owned cable) shall be installed approximately 12-inches below final grade (and at least 12-inches above the cable per NEC Section 300.5).

A suitable duct must be installed under public streets or ways, paved areas, driveways and all transmission rights-of-way.

Customers electing to install conduit for additional protection for direct buried cable will be required to meet all direct buried trench

requirements unless the conduit used meets the company's conduit specifications for a continuous conduit system.

912. Burial Depths

A minimum ground cover of 30-inches for cable operating above 600 volts phase to phase and 24-inches when operating at or below 600 volts phase to phase shall be provided. (Refer to illustration numbers 18, 19 and 20 in Section XII).

Galvanized steel conduit or heavy-wall, non-metallic conduit (Schedule 40 or 80) shall be used under public streets or ways, paved areas, driveways and all transmission rights-of-way. It shall be placed at least 36-inches below grade and shall extend at least four-feet beyond street limits or paved areas.

Conduit placed under private driveways and walks shall be at least 30-inches below grade and shall extend at least 24-inches beyond the traveled way.

Conduit may be used by the Customer outside public streets, ways, or paved areas and if used shall be galvanized steel or heavy-wall non-metallic at least 30-inches below grade for cable operating above 600 volts and at least 24-inches below grade for cable operating at or below 600 volts phase to phase.

Where ledge excavation is necessary and subject to advance company approval, a reduction of cover may be allowed where supplemental protection is provided as permitted by NESC Section 352 D or NEC Sections 300.5 and 300.50.

913. Separation of Facilities

The separation of direct buried secondary or primary cables and ducts containing secondary or primary cable from all other underground facilities (such as telephone, sewer, and water) will be in accordance with NESC Sections 320 and 353 and subject to approval by the company and the other utilities involved.

A minimum radial separation of 24-inches between the secondary or primary cables or ducts containing secondary or primary cables and all other utilities is required. The minimum separation may be reduced to 12-inches with the approval of all affected utilities. See illustrations 19 and 20 in Section XII. This separation is required to permit access to, and maintenance of, either facility without damage to the other.

914. Risers (Pole)

Risers on any pole shall be constructed in accordance with illustration number 29 or 30 in Section XII. Additionally, when more than one conduit **per utility** is to be installed on a single company pole or where future customers are likely to be served from the same pole, standoff brackets are required, and the riser shall be constructed in accordance with illustration number 28 in Section XII. This requirement includes the spare conduit (where required) which shall be run to the first standoff bracket (at least 8-feet above grade) and capped. If it is necessary to install brackets below the 8-foot level during construction, the brackets must be installed below finish grade or removed upon construction completion (before energization). This will ensure compliance with NESC requirements.

Bends at the foot of the pole, shall be made of galvanized steel and have a minimum radius as specified by the company (See paragraph 910).

Before any conduit is installed on a company owned pole, **the company shall be contacted to determine a suitable location** for the riser conduit. Once the riser location has been determined (in consultation with the company), the customer is responsible for installing the first 10' section or sections of conduit on the pole, including any conduit elbows or standoff brackets as required. Any additional sections of conduit will be installed on the pole by the company at the customer's expense. The customer is responsible for supplying all conduit and related hardware.

If the conductors are to be owned by the company, then the riser conduit (once installed on the pole) will become the property of, and will be maintained by, the company.

Galvanized steel conduit starting at a minimum of 18-inches below grade shall be provided wherever cable is extended above ground. In some cases, sunlight resistant schedule 40 or 80 PVC conduit, suitable for the purpose, may be substituted on the riser as detailed on illustration numbers 28, 29, and 30 in Section XII.

Proper consideration must be given to possible frost action in the selection of type and method of installation of ducts.

For a **customer owned primary** voltage riser, the customer is responsible for installing and owning the riser pole. This pole and the attached riser and conduits shall be constructed in accordance with the company's Construction Standards to include illustration numbers 28 and 29 in Section XII. With prior company approval, the riser may be attached to a company owned pole, but the company

will perform all installation and maintenance work on the riser at the customer's expense. The customer may also be assessed an annual pole attachment fee.

When the riser pole is located in a State road right-of-way, it is the customer/developer's responsibility to comply with the Maine Department of Transportation's Utility Accommodation Policy for conduits within the Maine Department of Transportation's right-of-way.

915. Multiple Services From One Pole

Multiple underground services from one pole will normally require separate service cables installed in separate conduits. Standoff brackets are required when more than one conduit is used, or is likely to be used, for any one utility. Refer to illustration number 28 in Section XII for specifications and materials for multiple risers on one pole. Where additional customers request service of similar characteristics through underground cable from a pole with an existing underground service, the company may, with Distribution Engineer approval and subject to the cost provisions of paragraph 903:

- Furnish and install a single conduit of adequate size for all the service cables, or
- furnish and install a single conduit and cable to a handhole for connection of the service cables, or
- furnish and install conduits and primary cables to a padmount transformer suitably located for connection of the service cables.

916. Cable and Duct Maintenance

The company will repair and maintain cable and duct systems owned by it. Repairs to company owned cable and duct due to normal hazards will be made at company expense including excavation, back fill, seeding and temporary service arrangements if necessary. The company will not be responsible for restoring major landscaping features (such as stone walls) that are damaged during repairs. Repair of company owned cable and duct caused by damage attributable to negligence on the part of another party will be billed to the party responsible for the damage.

The customer will be responsible for repair and maintenance of all cable and/or duct lines owned by the customer. The company will generally repair customer owned underground service **only** if it is built to company specification, using standard company specification cable. (Refer to cable Specifications in illustration number 32 in Section XII).

Such repairs will be billed to the customer.

At the customer's option, the company will provide a new underground service with company standard cable (see paragraph 905) to be company owned and maintained and requiring that the customer provide the trenching/back fill and conduit as required and pay costs per paragraph 903.

Any temporary arrangements made by the company to provide service to a customer because of failure of a customer owned underground, will be billed to the customer regardless of the ultimate repair/replacement of the permanent underground.

917. Transformer Vaults and Yards

Where high-capacity services are required, or where otherwise deemed appropriate by the company, the customer may be required to furnish, install, and **maintain** a suitable vault or fenced yard (including busses, raceways, and associated equipment) on the premises for the necessary transformers and protective equipment.

Such transformer vaults or fenced yards must meet the requirements of the NEC and NESC and be provided with outside easy access.

Specifications are subject to advance approval by the company. Information will be furnished upon request.

918. Temporary Service From Underground Facilities

Temporary service in underground (UG) areas will be installed only upon payment of the costs of installation and removal including the cost of all material not salvable for reuse. Provision for temporary service cannot be made until primary conductors and transformers have been installed.

Where the UG system is already in place the contractor may provide a suitable support for a meter and switch adjacent to the transformer. The customer/contractor will provide and install the secondary cable from the transformer to the meter. All connections to the transformer will be completed by qualified company employees.

Cable furnished by the contractor will not be maintained by the company.

For details of a UG service structure, see illustration numbers 9 and 11 in Section XII.

Where the UG system is to be installed as a part of a residential development, the contractor may provide a suitable support for

a meter at the approximate location of the permanent service and thereby avoid installation and removal costs of a temporary installation. NOTE: the UG service must be built to permanent service standards in order to take advantage of this method (See illustration numbers 8, 9, or 11 in Section XII). The company may furnish and install the URD cable in its permanent location with sufficient slack to allow for transfer onto the building, subject to the cost provisions of paragraph 903 and including payment for the final transfer. The contractor must arrange to protect the cable from damage and assume responsibility for the cost of any repairs or replacement required.

X. SERVICE FROM UNDERGROUND MAINS – URBAN

1000. General

In areas where the company maintains an **urban underground** distribution system, other than Underground Residential Distribution (URD), and the customer arranges to take service at the existing available voltage, the underground service connection between the company's mains and the customer's service entrance equipment will be furnished and installed in accordance with the requirements of this Section. No new services over 800a are permitted off the 120/208v Portland network system. For existing service upgrades contact CMP engineering.

1001. Duct Line Installation

The company will normally perform all necessary excavation and back-fill; as well as furnish, install, own, and maintain duct lines within the limits of the public street or highway.

The customer does, however, have the option to construct (in accordance with the company provided design and specifications), own and maintain the duct line within the limits of the public street or highway in accordance with the provisions of the MPUC's Chapter 395 on "Construction Standards, Ownership, Cost Allocation, and Customer Charges Rules for Electric Distribution Line Extensions and Service Drops" and, the company's filed tariff (T&C) on "Extensions." See paragraph 219 of this handbook for more details on customer constructed/owned lines.

1002. Terminal Box

Wherever a terminal box is required on the customer's premises, it will be furnished and installed by the customer to meet the company specifications.

For new 120/208V network services a manhole/ handhole will be installed in the sidewalk as a demarcation point between CMP cable and customer owned cable. If CMP engineering determines a mole cabinet is allowed, they will provide detailed requirements.

1003. Service Conductors

- A. Secondary Voltage - The company will furnish, install, own and maintain all conductors necessary from the point of connection to its underground mains to the nearest readily accessible point inside the customer's building where either the service entrance

equipment or a suitable terminal box may be located. However, the customer may be required to contribute the cost of the installation. The customer shall furnish and install all necessary conductors beyond the terminal box.

- B. Primary Voltage - The company will furnish, install, own and maintain all conductors necessary from the point of connection to its underground mains to the nearest readily accessible point inside the customer's vault (See Par. 304 of this handbook). However, the customer may be required to contribute the cost of the installation.

1004. Protective Equipment

The interrupting capacity required of service entrance equipment fed from underground mains should always be checked with the company before installing new services. Current limiters may be required in certain cases at the customer's cost. Service equipment fed from the Portland network system may be required to have 100,000 amperes interrupting capacity.

XI. UTILIZATION EQUIPMENT SPECIFICATIONS

1100. General

Electric service must not be used in such manner as to cause unusual fluctuations or disturbances in the company's supply system. Operation of the customer's equipment shall **not cause more than a 3% voltage fluctuation** on the company's primary distribution system. In the case of violation of this rule and subject to the Maine Public Utilities Commissions' Chapters 815, the company may refuse to connect service, may discontinue service, or require the customer to make modifications or install approved controlling devices. Motor and other installations connected to the company's lines may be restricted in the use of starting or inrush current and must conform to the requirements of the company and the NEC as to wiring, kind of equipment and control devices. The company will make the necessary calculations to determine the effect utilization equipment may have on its system.

1101. Motor Specifications

A. LIMITATION OF SIZE

The company reserves the right to refuse service to the following:

1. Single-phase motors larger than 5 hp. Single-phase motors of larger rating may be permitted, provided the company's facilities are adequate to supply the service and provided the use of such motor or motors does not interfere with the quality of service rendered to other customers.
2. Polyphase motors larger than 5 hp. operated from a single-phase service by use of a phase converter.
3. The company further reserves the right to limit the size of the largest motor which may be operated on any part of its system.

B. SINGLE-PHASE MOTORS

1. In general, single-phase motors up to 1 hp. may be operated on 120 volts. In certain cases, however, it may be necessary to operate these motors on 240 volts to obtain satisfactory results. All motors over ½ hp. should be operated on the higher voltage wherever feasible. Motors which are rated for 230 volts may not operate satisfactorily on 208 volts.
2. Motors are available in different types, designed for various kinds of loads and operating conditions. The manufacturer's recommendations should always be followed in determining the

type of motor to be installed. In all cases, the requirements of paragraph 1100 above, regarding fluctuations and disturbances in the company's supply system must be met.

C. POLYPHASE MOTORS

1. Standard "squirrel-cage" motors rated at 10 hp. and less may be started at full line voltage. For larger motors, the company reserves the right to require the customer to limit the motor starting current by the use of reduced voltage starters or other acceptable means.

1102. Protection And Control Specifications

- A. The customer shall be responsible for protection against low voltage or phase loss wherever low voltage, phase loss, or unexpected restarting could cause damage to the customer's equipment or result in personal injury.
- B. Overload protective devices shall be installed for all motors in accordance with the provisions of the NEC Section 430III.
- C. Control apparatus equipped with reverse phase relays of approved type shall be installed by the customer on all polyphase motor installations for elevators, hoists, cranes, and those manufacturing processes where accidental reversal of rotation is liable to cause injury to persons or damage to machinery, equipment or work in process.
- D. Customers are responsible to protect their electrical equipment from voltage transients caused by such events as lightning and internal and external switching. For more information about protecting electrical and electronic equipment, see the company's on-line publication at cmpco.com/handbook then click on CMP's Power Quality link.

1103. Power Factor Correction

The use of equipment by the customer for power factor correction must conform to requirements of the company as to electrical characteristics of equipment and its operation and control. The customer may be required to limit the size of static capacitor installations or to maintain effective control of the capacitors or other corrective equipment in order to prevent the use of such equipment from causing excessive voltage at the service. Corrective equipment installed by the customer must be located on the load side of the service disconnecting device and metering.

1104. Harmonic Loads

Equipment that draws current with a high harmonic content can have a serious impact on the quality of the company's service. The company requires that any service comply with the maximum harmonic current distortion limits given in IEEE Standard 519-2014. Table 10.3 of that standard provides the limits for individual harmonic distortion and Total Demand Distortion as a percent of maximum demand load current. A maximum Total Demand Distortion of 5% is generally required at the point of common coupling as defined in IEEE Standard 519-2014.

Examples of equipment that draw high harmonic content current include variable speed and variable frequency drives, computer power supplies, electronic lighting ballasts and rectifiers.

XII. Illustration No. 1

980-31.1.1 / SINGLE-PHASE CABLE SERVICE - 200 AMP MAX

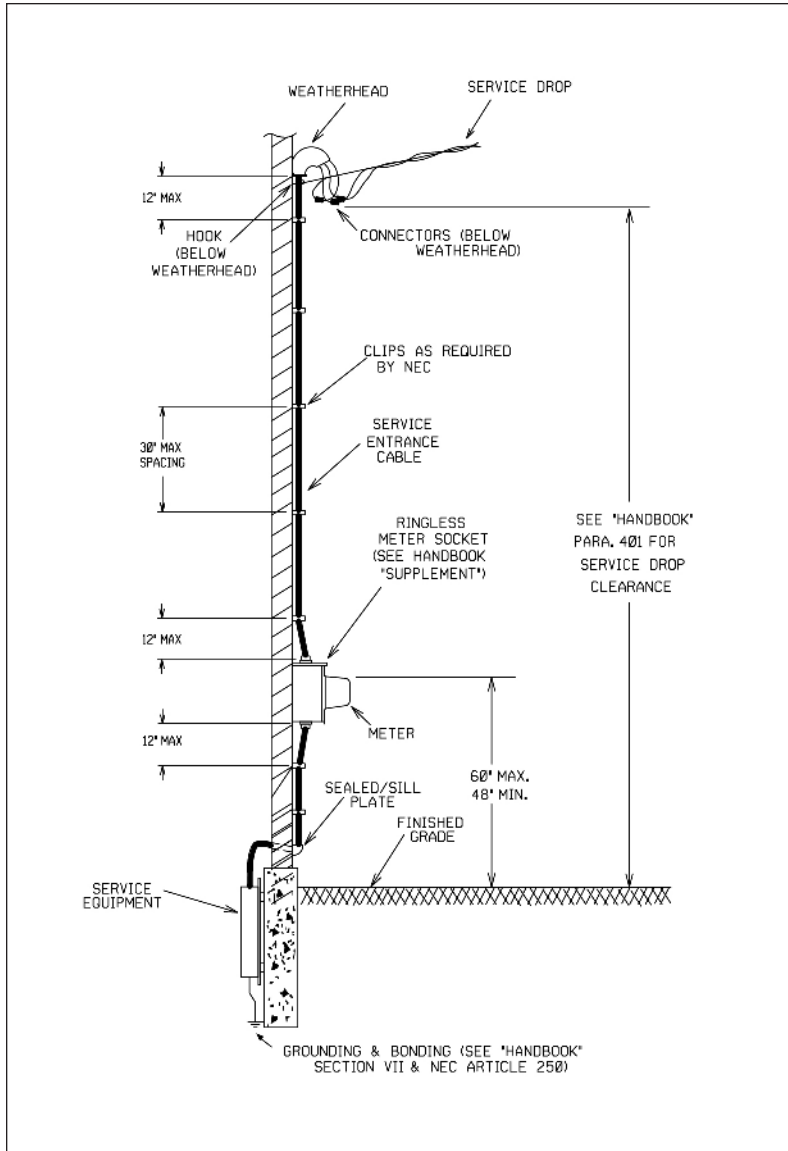

XII. Illustration No. 2

980-31.1.2 / CONDUIT SERVICE 400 AMP MAX

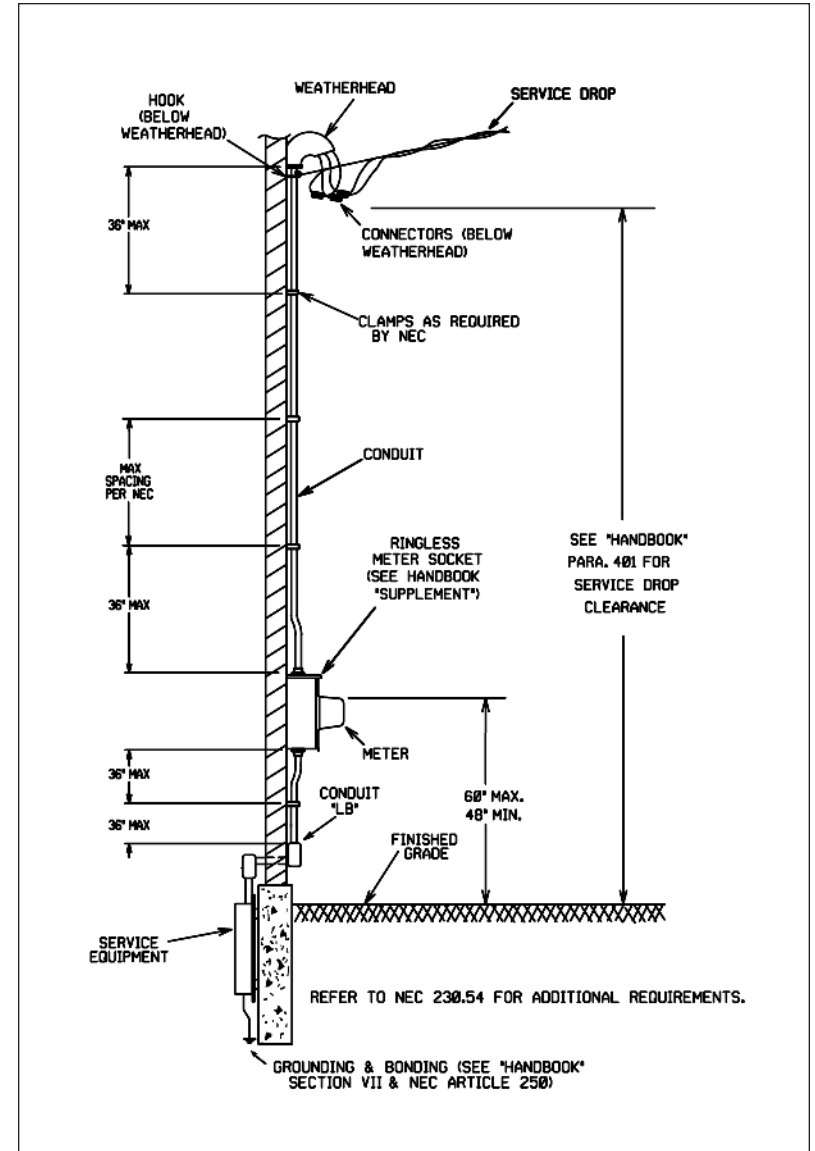

XII. Illustration No. 3

980-31.1.3 / RIGID STEEL MAST TYPE SERVICE TO LOW BUILDING

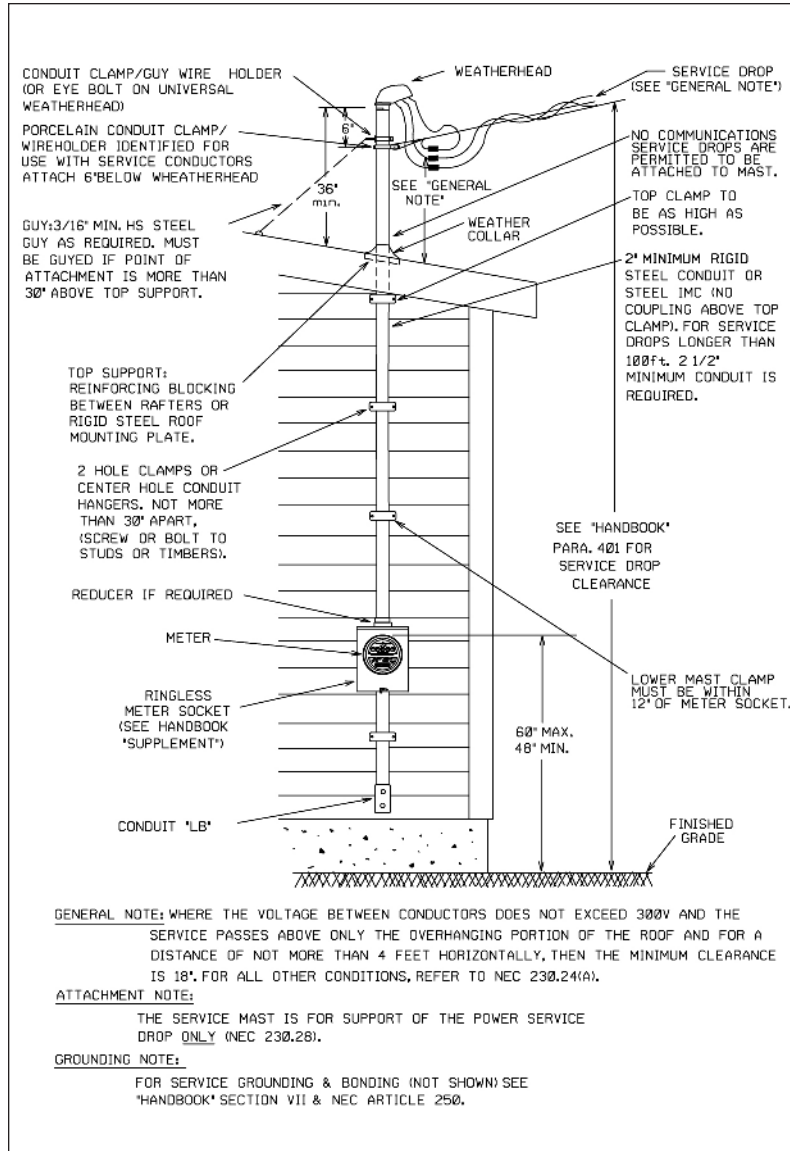

XII. Illustration No. 4

980-31.1.6.1 / POLE MOUNTED SERVICE/METER

Items Supplied and Installed by CMP:

- Service drop
- Service drop connectors
- Service drop hook
- Meter

Items Supplied by Customer and Installed by CMP:

- (2) Preformed or equivalent guy grips 5/16"
- Guy wire 7 strand 5/16" EHS x required length (allow for bonding to NEUTRAL)
- Guy marker PVC 8ft.

Items supplied and installed by Customer:

- Pole, pressure treated (see Note 4)
- Weatherhead
- Clamps, (two hole on a round pole), spaced as required by NEC.
- Meter backboard (see Note 2)
- Meter socket, ringless (See Handbook "Supplement")
- Conduit (highly recommended) or cable,
- Rain-tight service equipment (see Note 1)
- Grounding conductor (see Note 3)
- Ground rod, 5/8" x 8' copperweld or galvanized steel (minimum)
- Ground rod clamp
- Feeder or Supply cord per NEC (see note 1)
- Anchor, No-wrench screw type, one piece, 3/4" rod, 6' helix, 66" overall length

**or t. Anchor, expanding with a minimum area of 70 sq. in. when expanded. Anchor must be expanded!

**or t. Anchor, steel crossplate with a minimum area of 150 sq. in.

u. (2) Washers 2-1/4" x 2-1/4" x 3/16"

v. Guy hook for 5/16" stranded guy

*w. Bolt, machine square galvanized 5/8" x required length

*x. Bolt, toe 1/2" x 4"

(Items v, w and x may be replaced by using an angle type thimble eye bolt.)

NOTES:

- This Standard is typically for a mobile home service (Handbook, para. 408A.) but may be applied anywhere that overhead service conductors terminate on a customer owned service/meter pole (Handbook, para. 404). The service disconnect and overcurrent device under the meter may not be required for all applications, but it is highly recommended in order to allow the customer to disconnect and maintain their underground conductors without the cost of a CMP line crew visit. See "Handbook" illustration No. 31 for allowable customer owned residential service lengths.
- The meter backboard horizontal framing shall be 1-5/8" X 1-5/8" 12 ga. minimum galvanized or "gold-guard" (or equivalent) steel channel (strut type is acceptable) mounted to the back of the post either directly or by using a standoff bracket. Shim as required to plumb the enclosure.
- Service bonding and grounding shall be as required by "Handbook" section VII and NEC article 250. For meter only (no disconnect) installations, the meter enclosure shall be grounded (at a minimum) to a "supplementary" ground rod (5/8" X 8').
- The pole shall be pressure treated full length (or untreated cedar), have a minimum diameter of 8" at ground line and 6" at top, and be of sufficient height to provide proper service drop clearance. A 6' X 6" (or larger) pressure treated timber is acceptable. If timber is selected, attached service cable length is limited to 150'. The guy "lead" dimension shall be a minimum of 10 feet or 1/3 the height of the pole (above ground), whichever is greater.
- The anchor and rod are a one piece galvanized unit. To manually install anchor, place a turning bar through the rod eye and rotate anchor clockwise. If full-depth installation cannot be achieved by this method, then a hole may be dug to full-depth, anchor placed and the hole backfilled and tamped with stones and dirt.
- For the expanding anchor and the crossplate anchor, an anchor rod with a minimum diameter of 5/8" and a minimum length of 6 feet must be ordered separately in addition to the anchor.

XII. Illustration No. 4 (continued)

980-31.1.6.2 / POLE MOUNTED SERVICE/METER

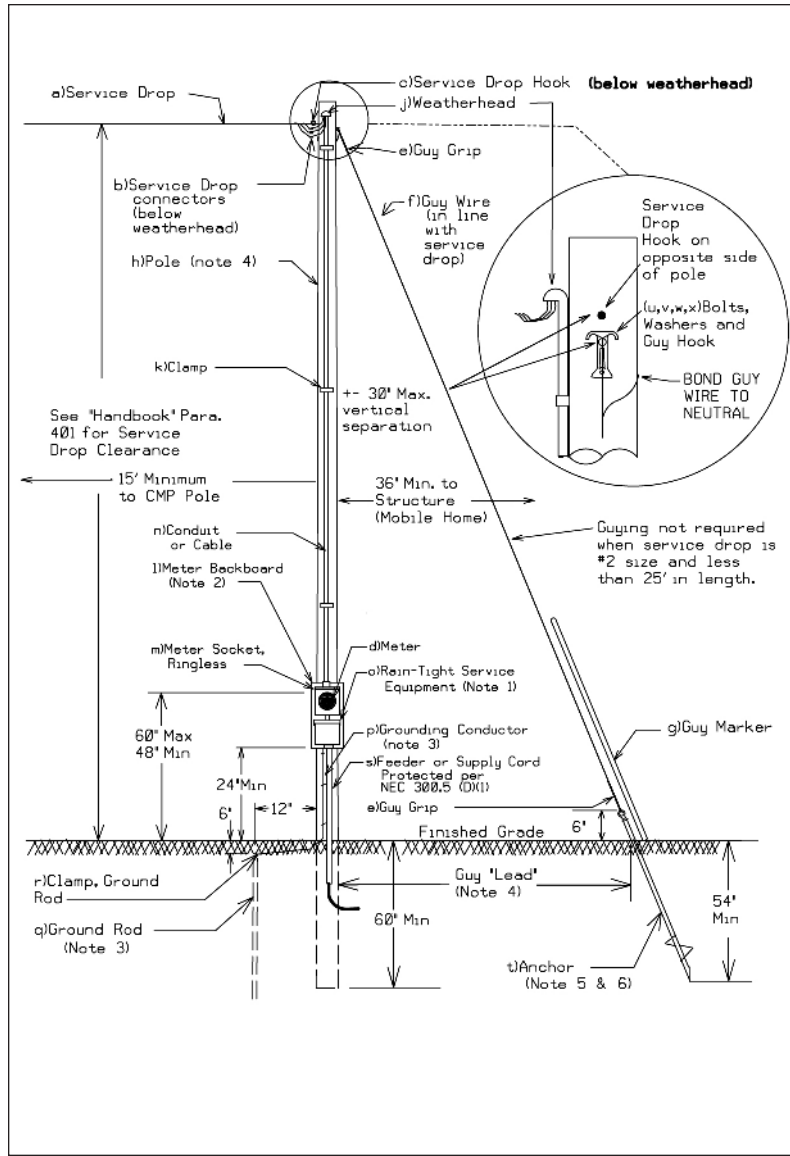

XII. Illustration No. 5

980-31.1.6.3 / MULTI-METER SERVICE POLE/PEDESTAL

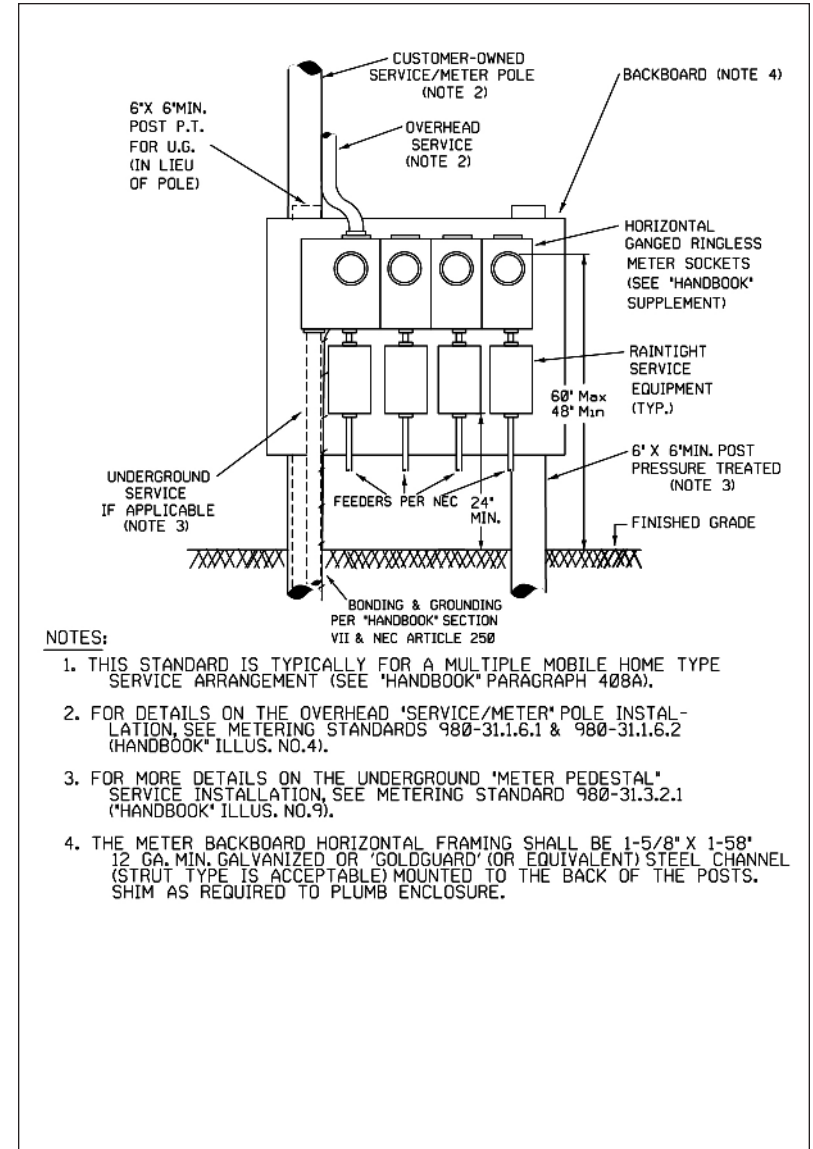

XII. Illustration No. 6

980-31.4.3.1 / CATV POWER SUPPLY INSTALLATION

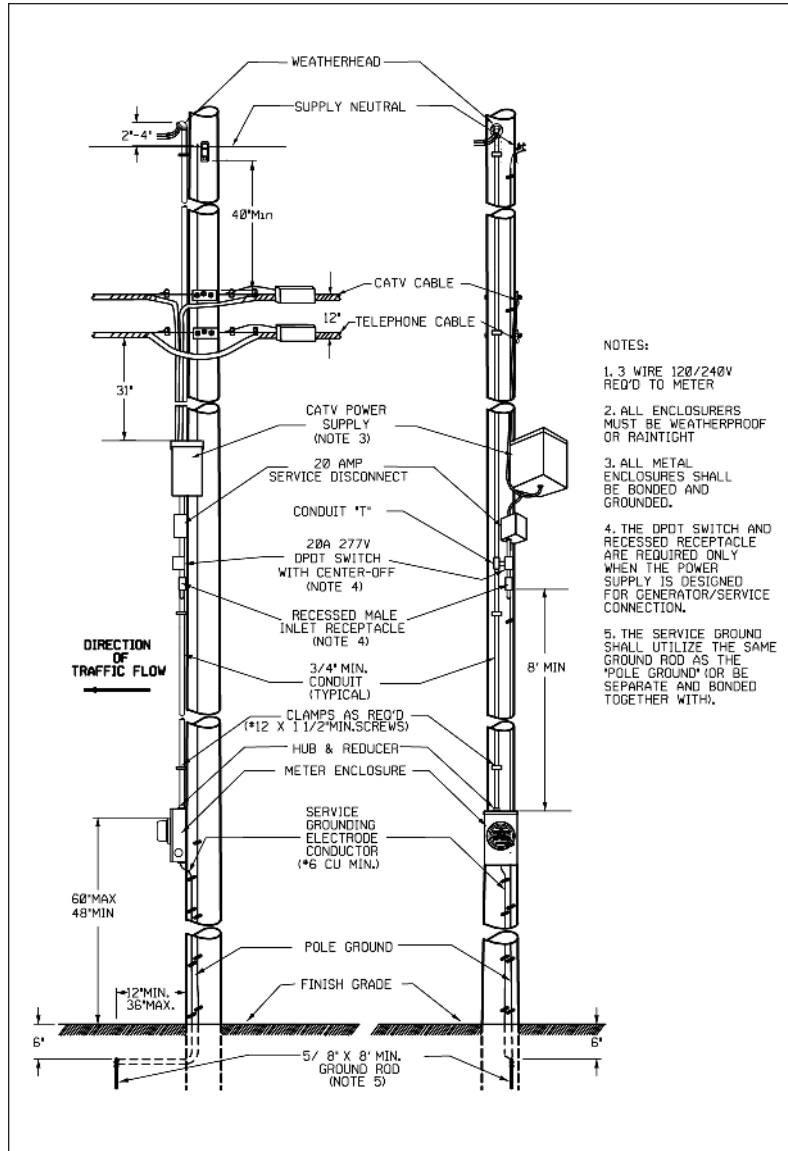

XII. Illustration No. 7

980-31.1.4 / TEMPORARY SERVICE STRUCTURE 200 AMP MAX

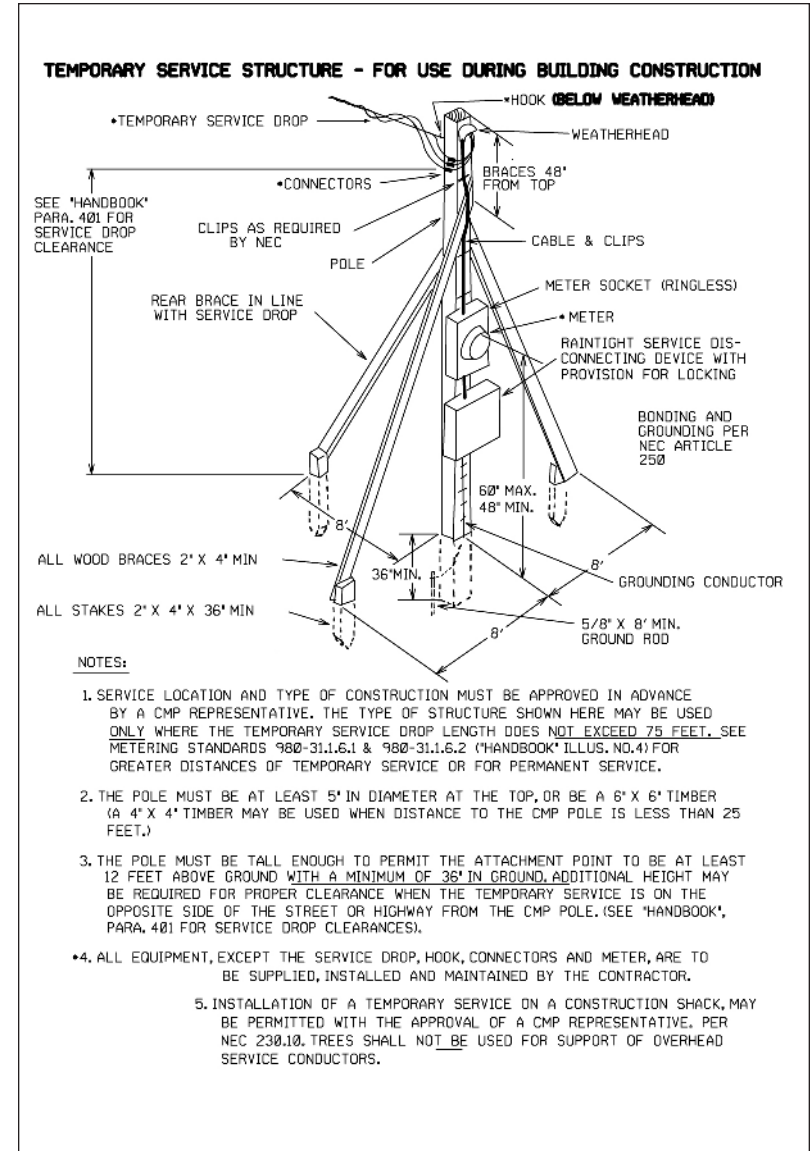

XII. Illustration No. 8

980-31.3.1 / UNDERGROUND SERVICE 400 AMPERES MAX

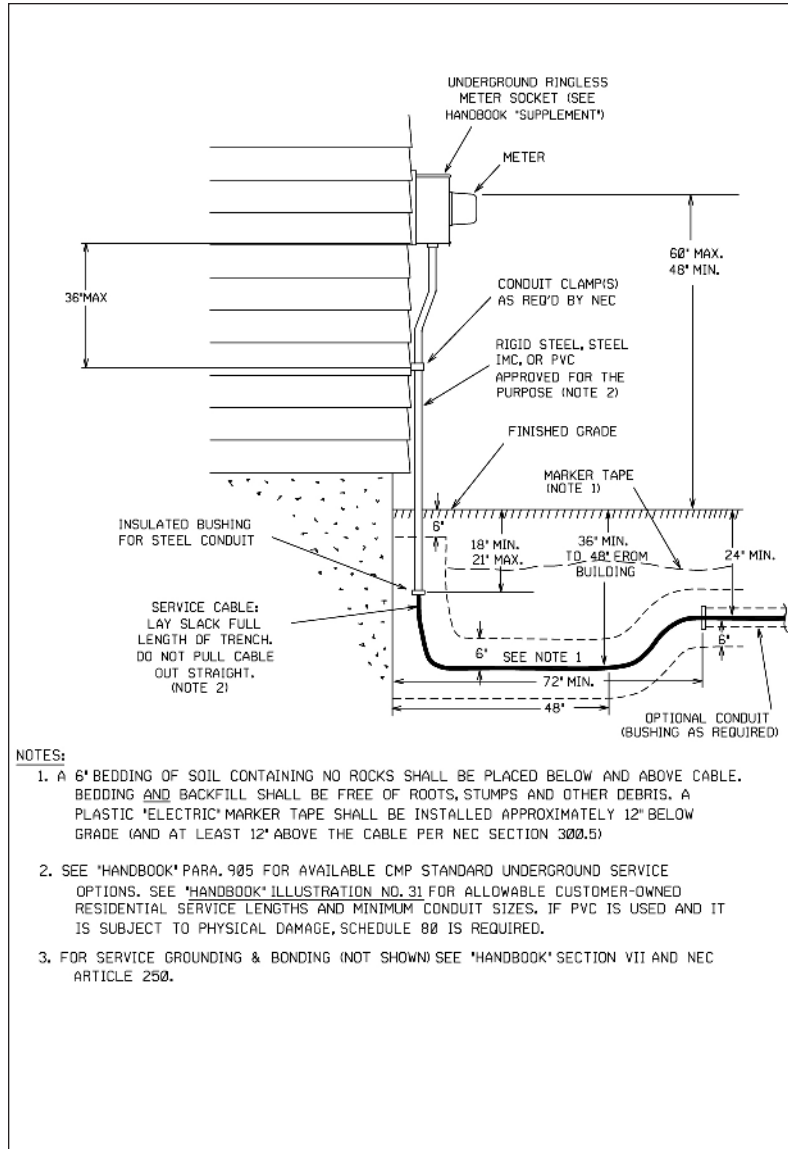

XII. Illustration No. 9

980-31.3.2.1 / METER PEDESTAL SERVICE 200 AMP MAX

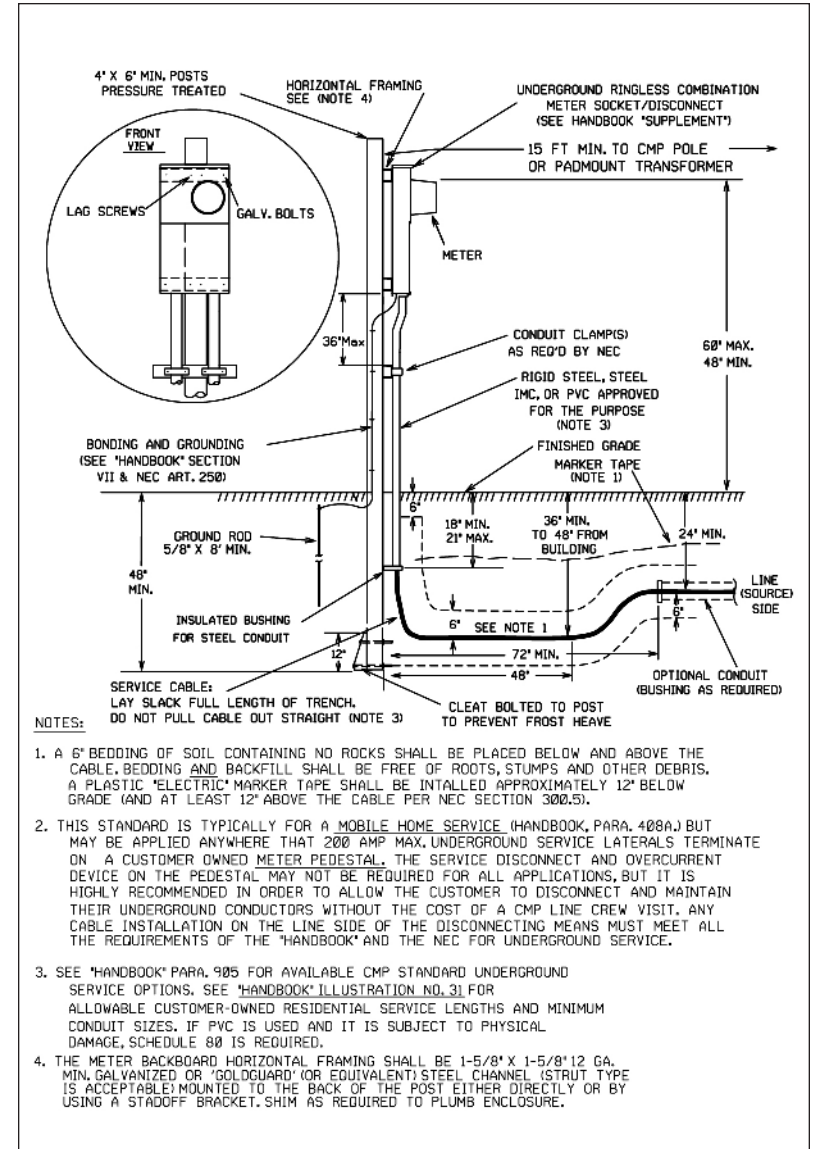

XII. Illustration No. 10

980-31.3.3 / UNDERGROUND SECONDARY SERVICE CONTINUOUS CONDUIT

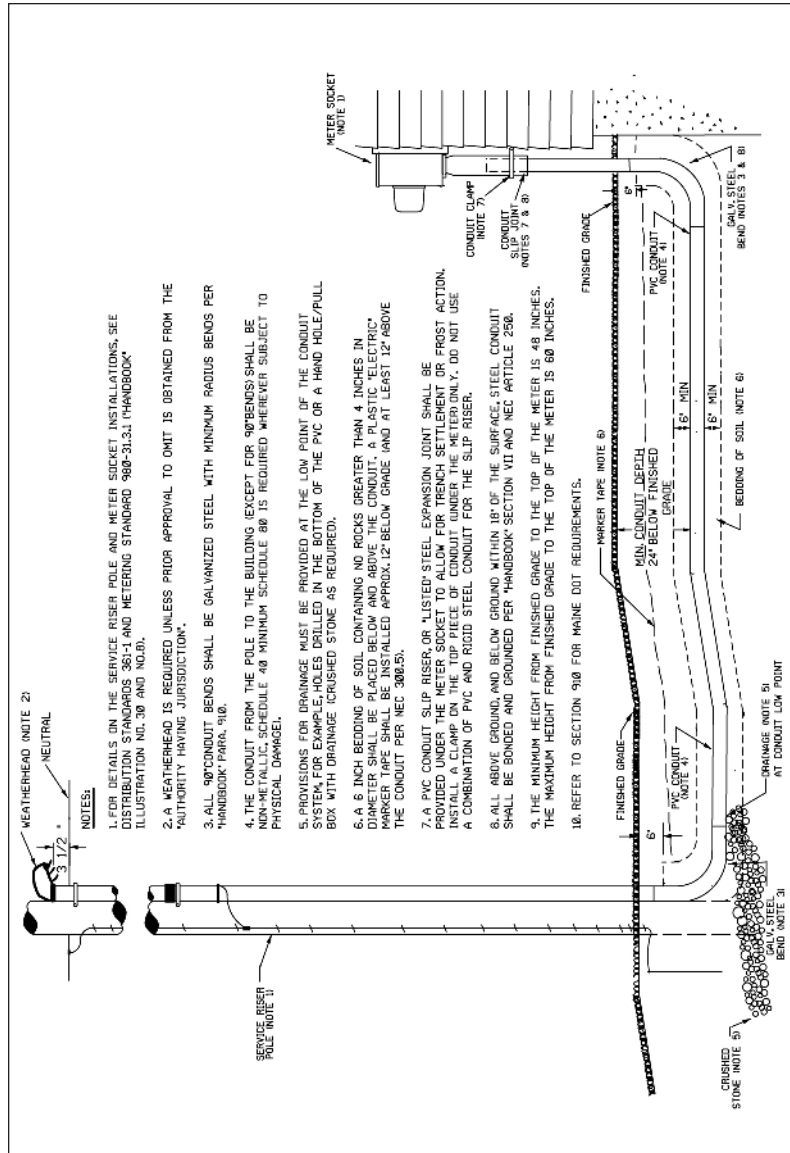

XII. Illustration No. 11

980-31.3.2.2 / METER PEDESTAL SERVICE 400 AMP MAX

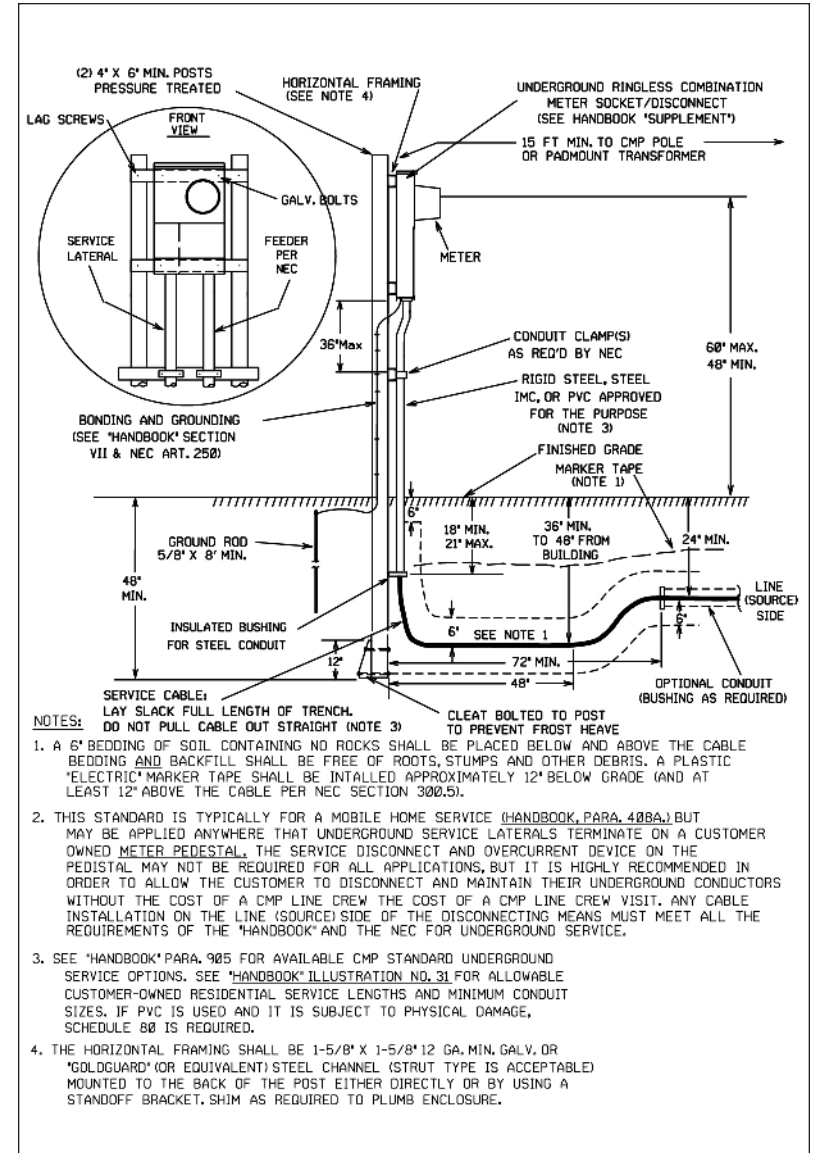

XII. Illustration No. 12

980-31.1.8 / MODULAR METERING, TYPICAL

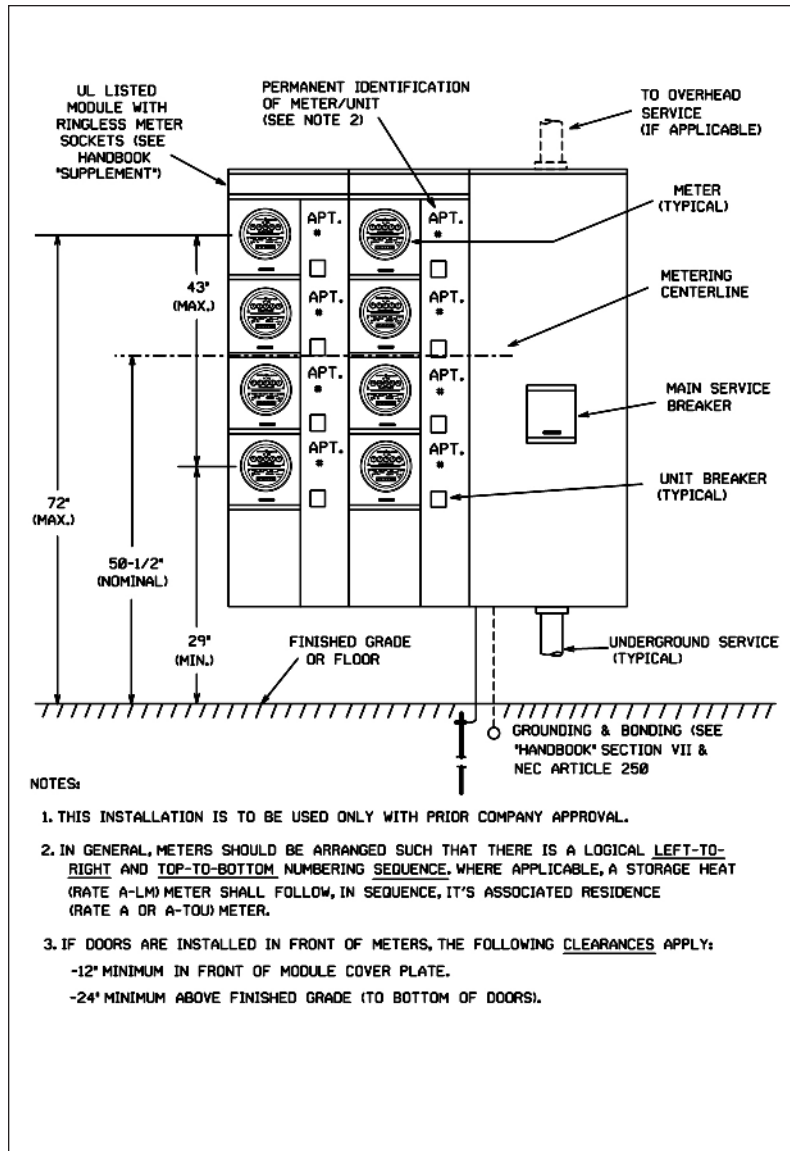

XII. Illustration No. 13

980-31.1.7 / SELF-CONTAINED METER SOCKET CONNECTIONS

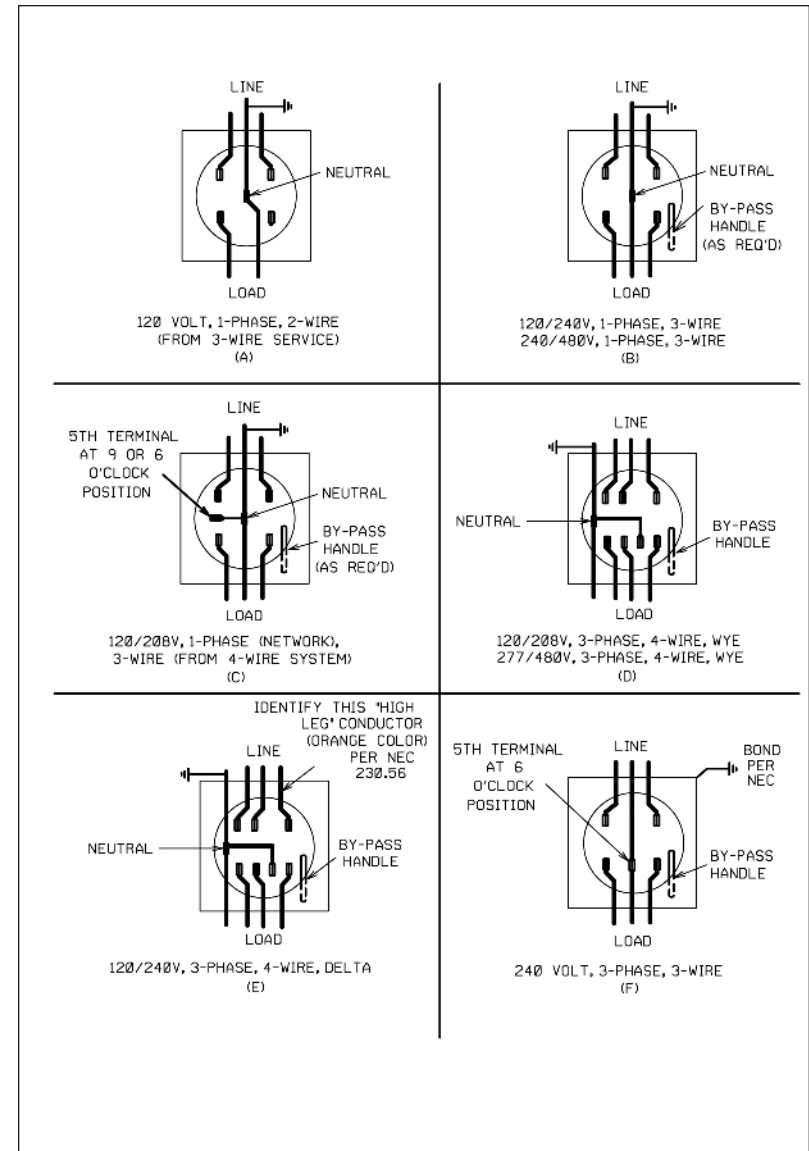

XII. Illustration No. 14

980-31.2.4 / WALL MOUNTED OUTDOOR CT CABINET & OVERALL METER ENCLOSURE

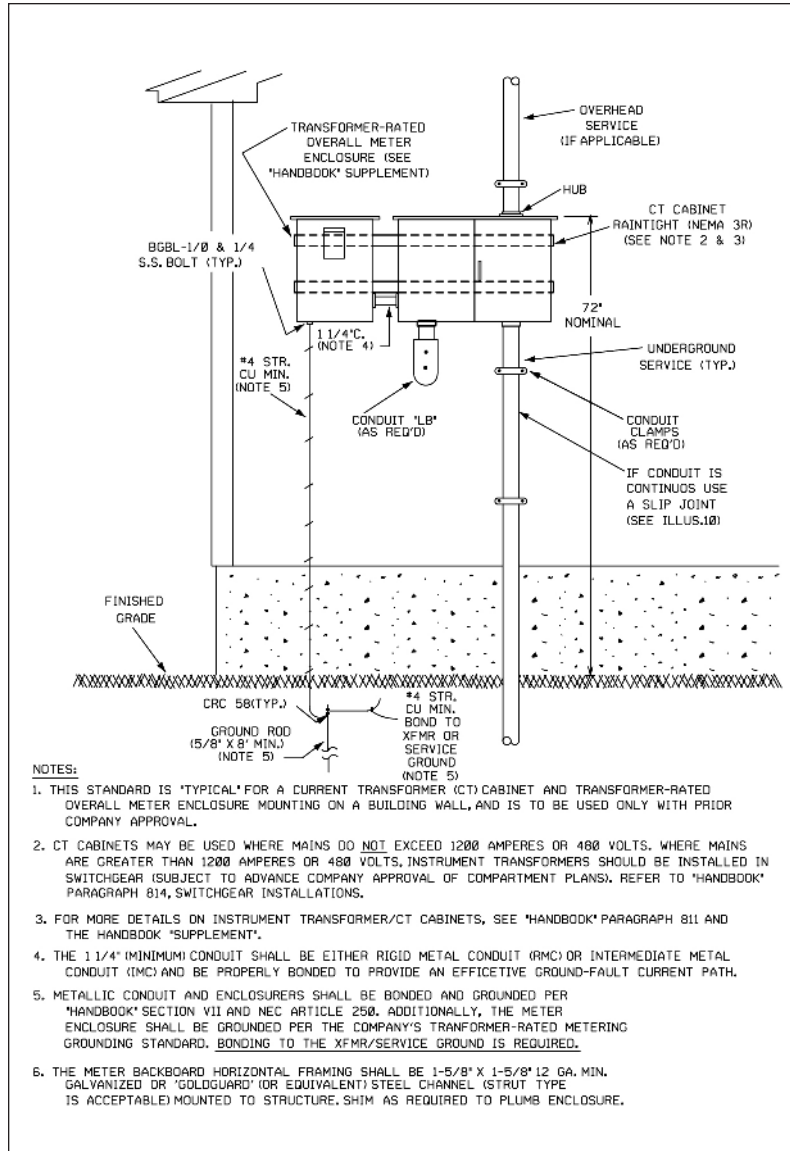

XII. Illustration No. 15

980-32.1.1 / POLE-MOUNTED OUTDOOR OVERALL METER ENCLOSURE MOUNTING

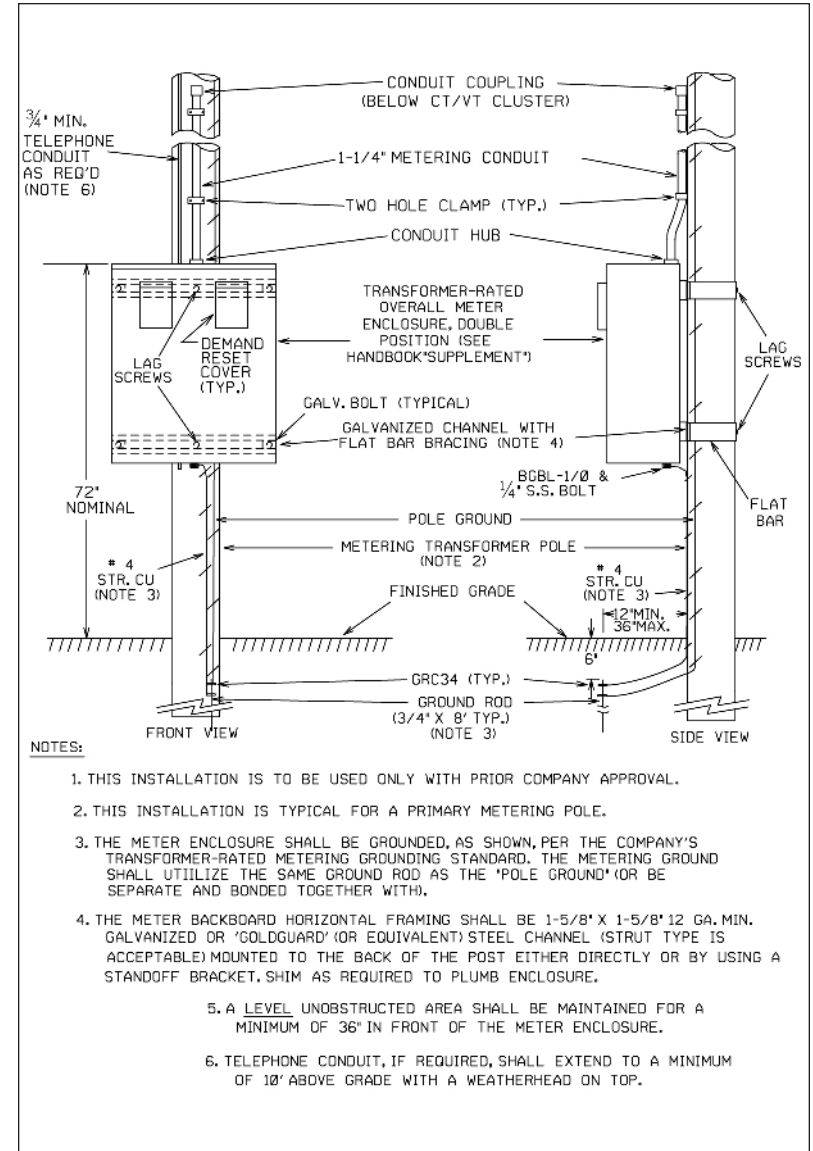

XII. Illustration No. 16

980-32.1.3 / UNDERGROUND OUTDOOR OVERALL METER ENCLOSURE MOUNTING (1-SINGLE)

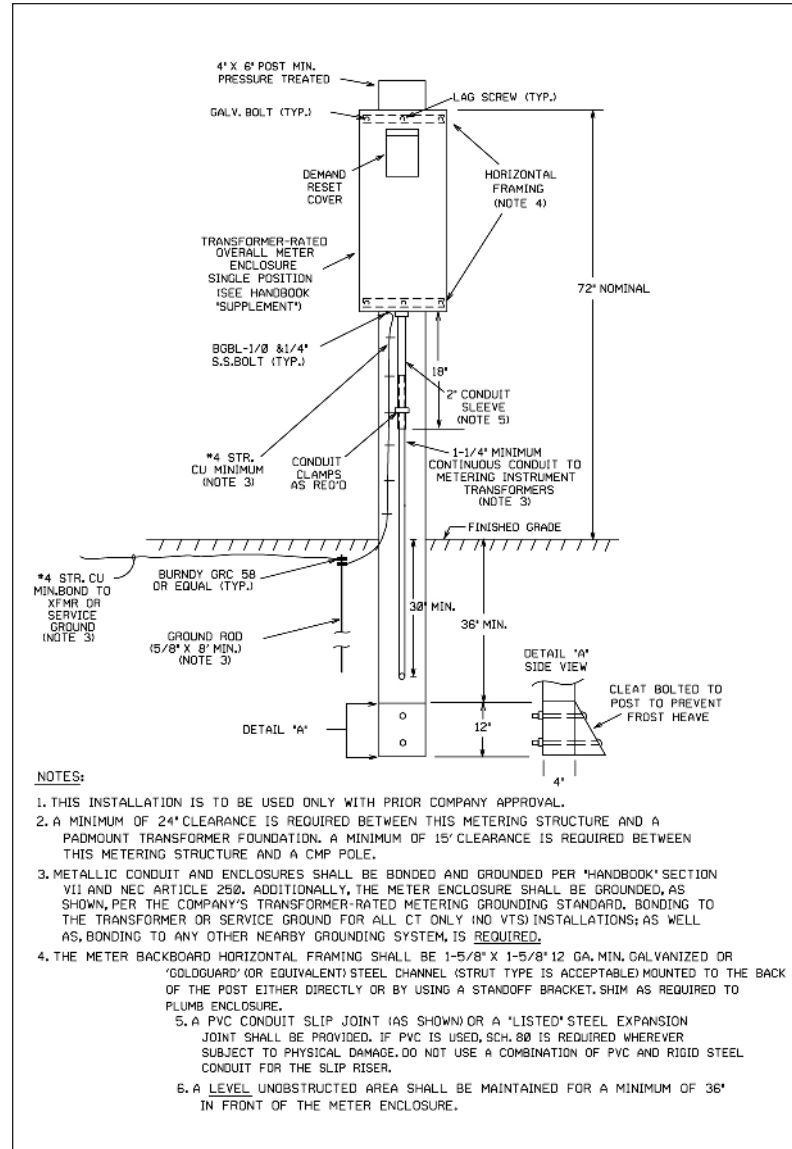

XII. Illustration No. 17

980-32.3.2 / UNDERGROUND OUTDOOR OVERALL METER ENCLOSURE MOUNTING (1-DOUBLE)

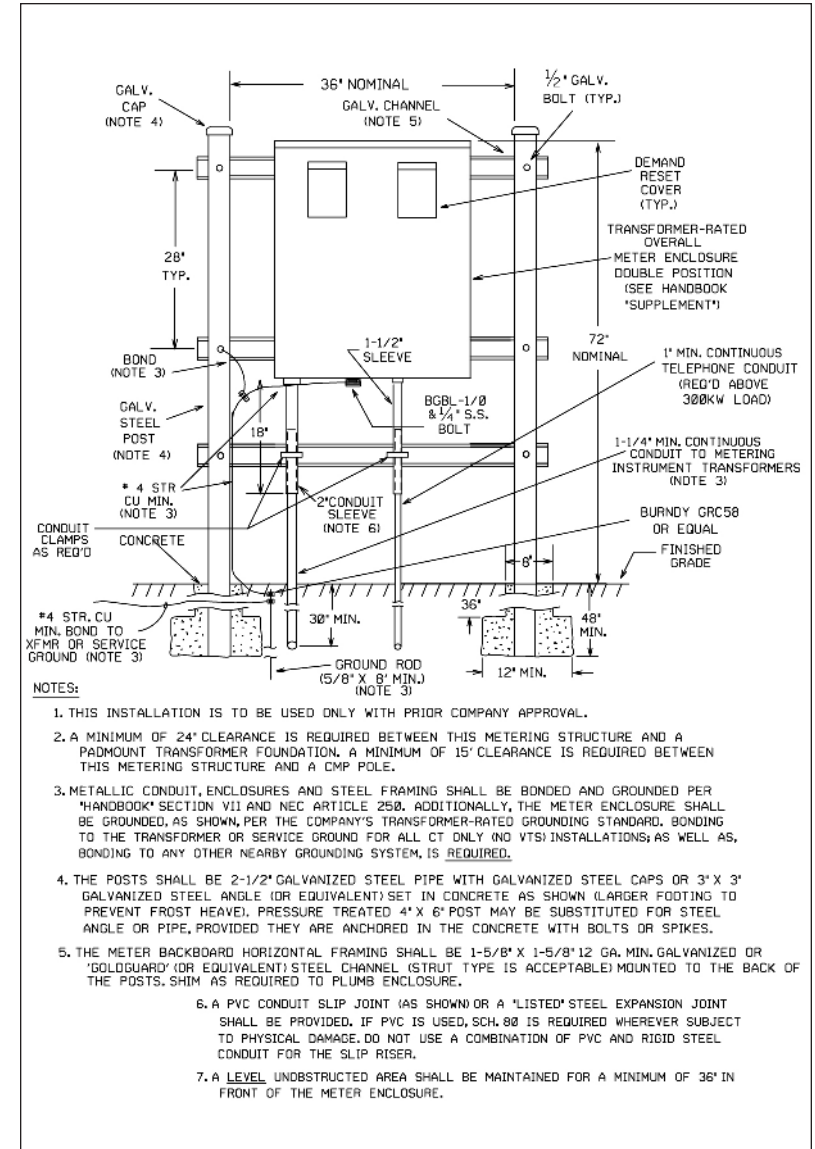

XII. Illustration No. 18

363-3 / UNDERGROUND CABLE TRENCH FOR POWER ONLY

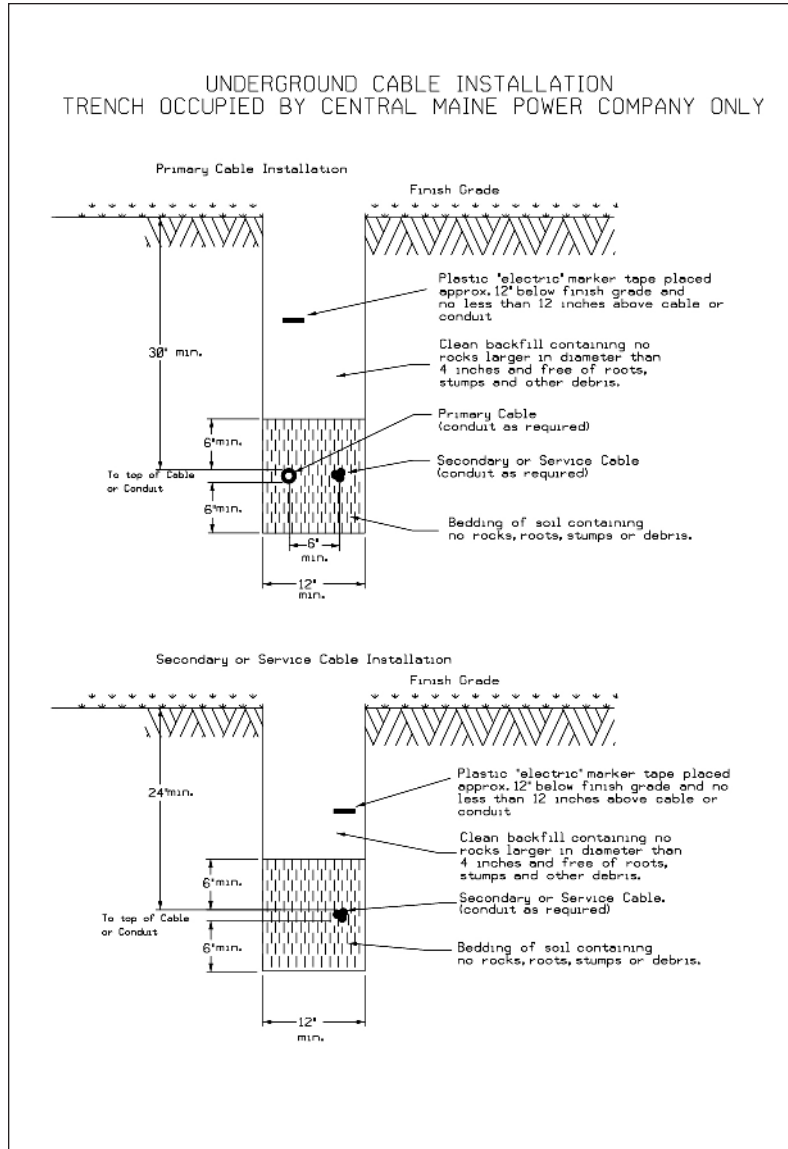

XII. Illustration No. 19

363-4 / UNDERGROUND CABLE INSTALLATION JOINTLY USED TRENCH HORIZONTAL SEPARATION

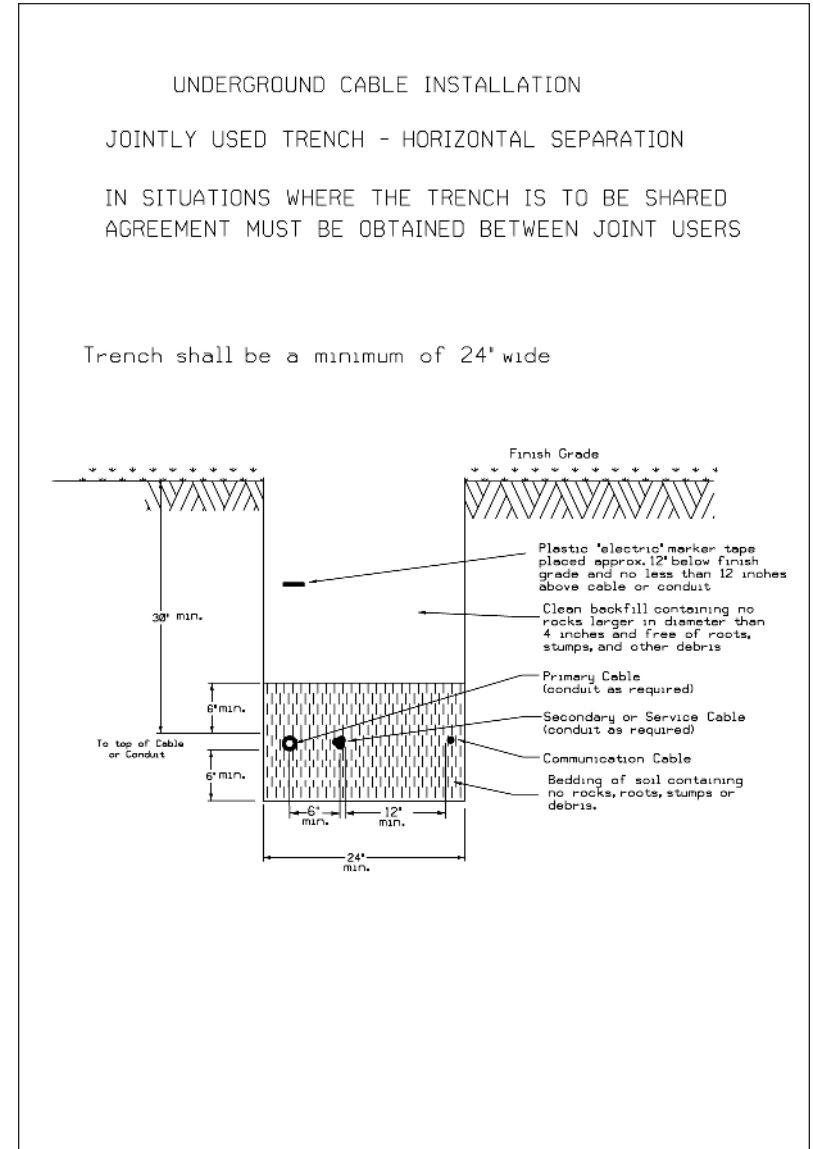

XII. Illustration No. 20

363-5 / UNDERGROUND CABLE INSTALLATION JOINTLY USED TRENCH VERTICAL SEPARATION

UNDERGROUND CABLE INSTALLATION

JOINTLY USED TRENCH - VERTICAL SEPARATION

IN SITUATIONS WHERE THE TRENCH IS TO BE SHARED
AGREEMENT MUST BE OBTAINED BETWEEN JOINT USERS

NOTES:

1. Installation should not allow the inter-twining of cables.
2. Bedding and backfill shall be free of roots, stumps and other debris.
3. Communication cable and power cable shall have no less than 12 inches of radial separation.

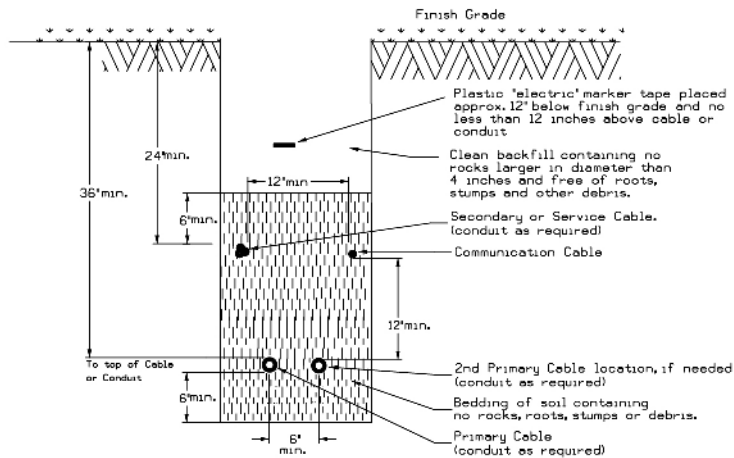

XII. Illustration No. 21

364 / PADMOUNT TRANSFORMER AND CABLE LAYOUT

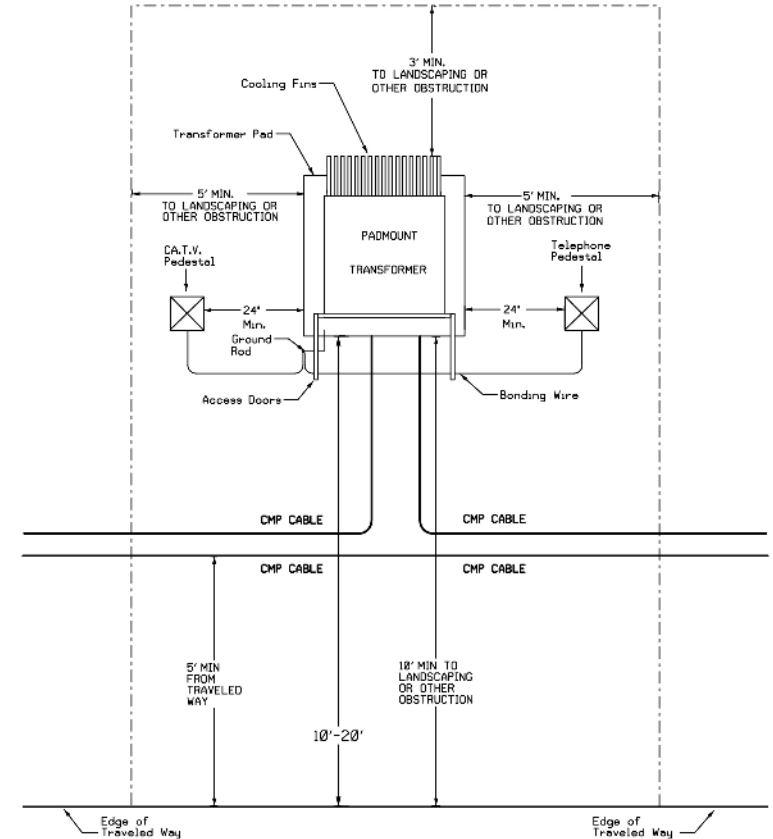

Preferred layout of a padmount transformer and direct buried underground distribution system. Prior CMP approval is required for any deviation from this layout.

At each transformer location a level 10 foot by 10 foot (minimum) area will be provided. The elevation of this area shall be sufficiently high to always be above the highest expected water level and at or above the top of any nearby ditch slope. The transformer foundation shall be installed so the top of the foundation is 6 inches above this elevation. The transformer foundation shall be installed no more than 20 feet from a road surface.

XII. Illustration No. 22

364-4 / PRIMARY JUNCTION BOX FIBERGLASS COVERS

PRIMARY JUNCTION BOX FIBERGLASS COVER

1. The fiberglass pad CU C6UDJBFP (MID*6000673961) is suitable for both 7.2/12.47kv and 20/34.5kv single phase junction boxes.
2. Use fiberglass flat cover CU C6UDJBFCF (MID*6000673931)
3. Fiberglass flat cover CU C6UDJBFCF (MID*6000673931) requires a minimum of 2 one time locks (MID*6000821013) installed opposite each other.

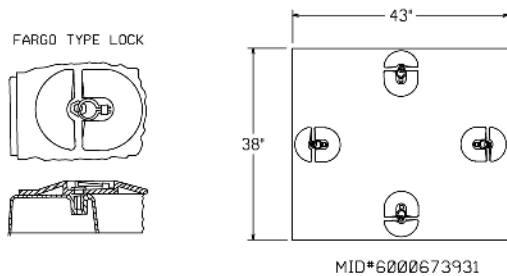

XII. Illustration No. 23

364-5 / SINGLE-PHASE CONCRETE TRANSFORMER FOUNDATION 25 TO 167 KVA

NOTES:

1. FRONT denotes the side on which the access doors are located. The concrete base shall be set on a suitable gravel base and located so the FRONT is accessible by truck and suitably protected from plow and traffic damage.
2. Before installing or requiring any active drainage structure (e.g., drain pipe) into the foundation or pad, the contractor, CMP Line Supervisor, or CMP Distribution Engineer must contact Central Maine Power Company's Environmental Services Department at 623-3521 ext. 3479 to request a site inspection.
3. Finish grade shall be graded in such manner to allow surface water to flow away from the pad.
4. Concrete foundation is suitable for both 7200/12470 volt and 20/34.5Kv single phase transformer and primary junction box installations.
5. Provide 6" square cable holes (bond out) 3' up the wall from the base. One per wall.
6. Conduit entering concrete structures shall be set back from the inside wall 1 to 2 inches and the space within the knockout surrounding the conduits completely filled with mortar to prevent soil from entering structure. Inside the structure the mortar shall be finished and beveled from the conduit ends to the inside wall face to cover and smooth the edges of the knockouts.
7. A 3/4" x 8' galvanized ground rod is to be installed 6' in front of the left front corner of transformer foundation. The top of the ground rod is to be 6' below final grade.
8. A ground wire shall be installed from the ground rod through the 1/2" ground wire hole provided or the cable hole at the bottom of the pad. 10 Feet of ground wire shall be provided so that it can be installed through the two grounding lugs and connected to the neutral spade.
9. Pulling eye insert, for use with 3/4" national coarse thread eye-bolt (Richmond LCB-1 or equivalent). Located opposite each cable hole and approximately 16" from the bottom.

XII. Illustration No. 23 (continued)

364-6 / SINGLE-PHASE CONCRETE TRANSFORMER FOUNDATION 25 TO 167 KVA

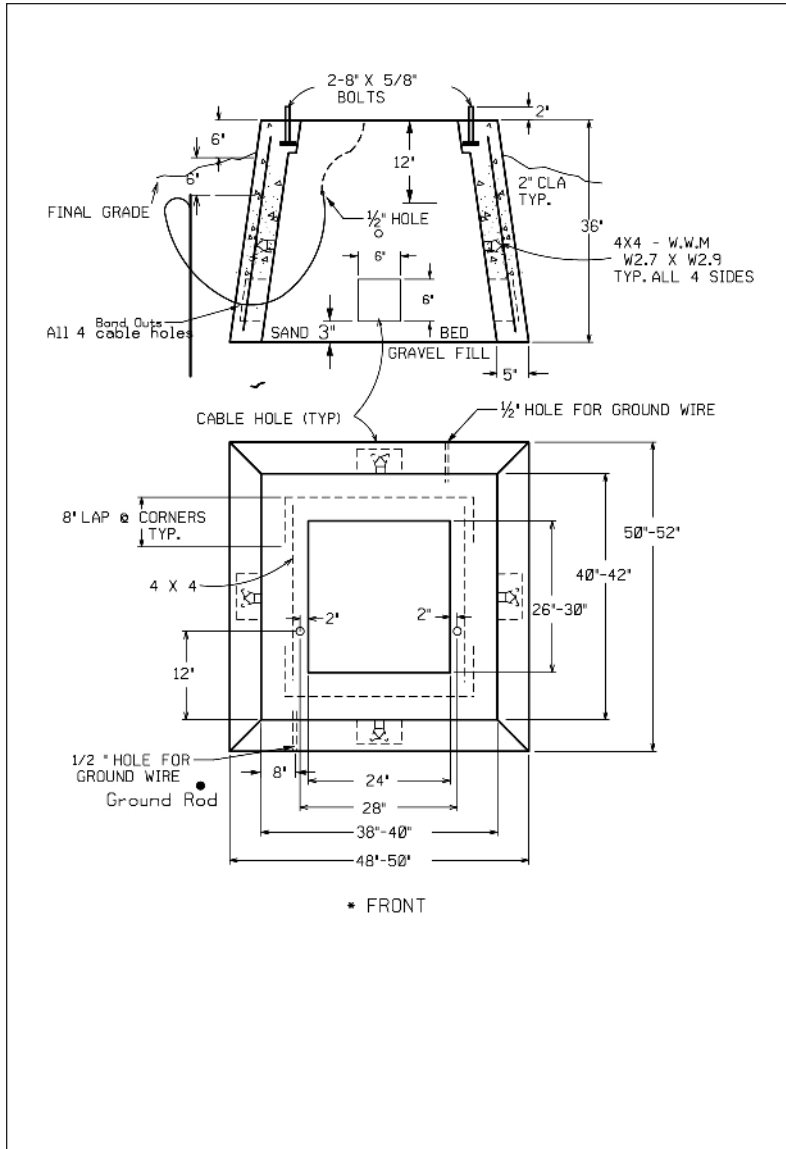

XII. Illustration No. 24

364-7 / SMALL 7' X 7' THREE-PHASE TRANSFORMER FOUNDATION

NOTES:

1. FRONT denotes the side on which the access doors are located. The concrete base shall be set on a suitable gravel base and located so the FRONT is accessible by truck and suitably protected from plow and traffic damage.
2. Before installing or requiring any active drainage structure (e.g., drain pipe) into the foundation or pad, the contractor, CMP Line Supervisor, or CMP Distribution Engineer must contact Central Maine Power Company's Environmental Services Department at 623-3521 ext. 3479 to request a site inspection.
3. Finish grade shall be graded in such manner to allow surface water to flow away from the pad.
4. Provide 8' x 24' cable holes (bond outs) 8' up the wall from the base. Locate one cable hole per wall, more if necessary. Line up cable holes with trench.
5. Conduits entering concrete structures shall be set back from the inside wall 1 to 2 inches and the space within the knockout surrounding the conduits completely filled with mortar to prevent soil from entering structure. Inside the structure the mortar shall be finished and beveled from the conduit ends to the inside wall face to cover and smooth the edges of the knockouts.
6. A 3/4" X 8' galvanized ground rod is to be installed six inches in front of the left FRONT corner of the foundation. The top of the ground is to be 6 inches below final grade.
7. A ground wire shall be installed from the ground rod through the cable hole at the bottom of the pad. 10 Feet of ground wire shall be provided so that it can be installed through the two grounding lugs and connected to the neutral spade.
8. Concrete compressive strength shall be 4000 PSI @ 28 days. For cast-in-place early high strength may be used with a minimum of seven day cure time.
9. Reinforcing steel to have: FY = 60 KSI.
10. The precast supplier shall provide lifting lugs in the slab (foundation) and base; the precast supplier shall assemble the slab to the base prior to shipping to the site to ensure that the slab and base fit properly (with no rocking of the slab evident).
11. Use a 16' x 24' x 1/4' galvanized steel plate to cover a portion of the cable hole when the transformer does not completely cover it. Cut the steel plate to fit, if necessary.
 - a. 7-#5 Rebar evenly spaced each way top to bottom.
 - b. 2-#4 Corner diagonal rebar 2'-0" long top and bottom.
 - c. A 3/4" deep by 9" wide groove on the underside of the pad top shall be provided to keep the top in place.
 - d. Chamfer typical
 - e. 2" Concrete cover over top rebar.
 - f. 3" Concrete cover over bottom rebar.
 - g. 16' x 24' x 1/4' galvanized steel plate. MID#6000621790
 - h. #5 Rebar on 12' centers.
- i. Pulling eye insert, for use with 3/4" national course thread eye-bolt, (Richmond LCB-1 or equivalent). Located opposite each cable hole and 2' (two feet) from the bottom.
- j. All rebar ends to be covered by 1' of concrete, minimum.
- k. For cast-in-place construction, see Distribution Engineer.

XII. Illustration No. 24 (continued)

364-8 / SMALL 7' X 7' THREE-PHASE TRANSFORMER FOUNDATION

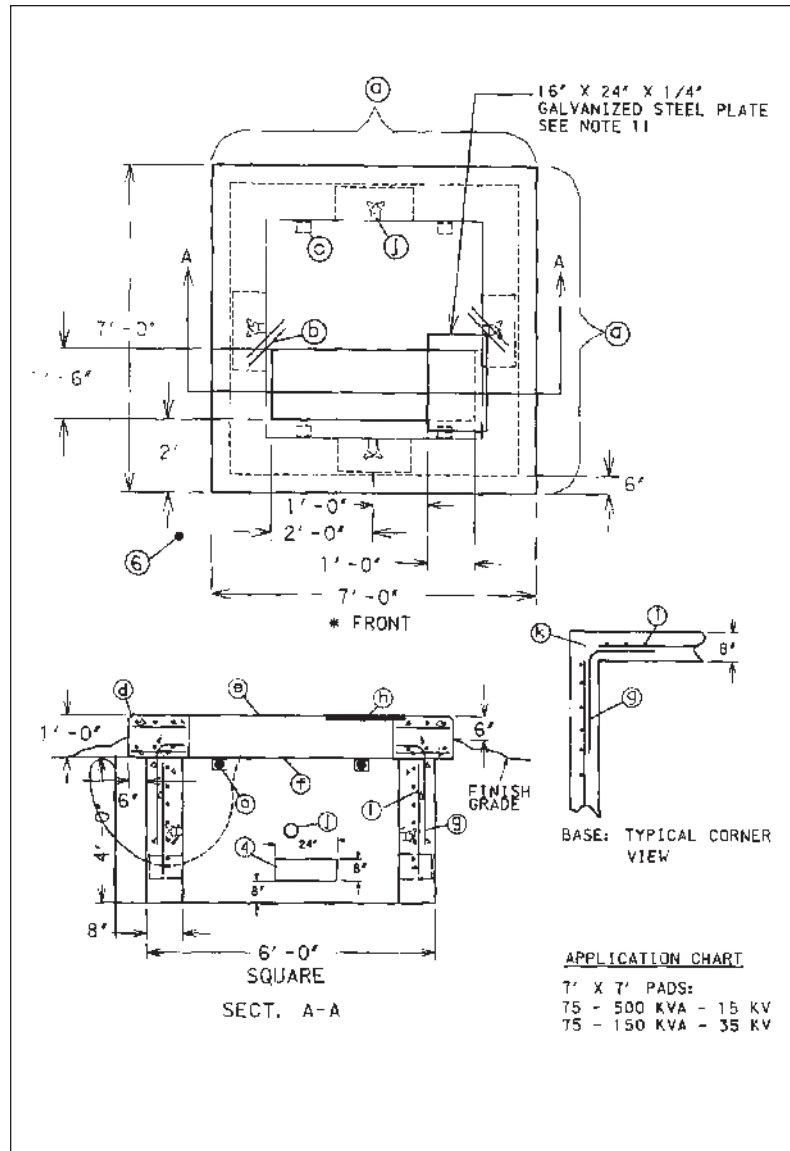

XII. Illustration No. 25

364-9 / LARGE 9' X 9' THREE-PHASE TRANSFORMER FOUNDATION

NOTES:

- FRONT denotes the side on which the access doors are located. The concrete base shall be set on a suitable gravel base and located so the FRONT is accessible by truck and suitably protected from plow and traffic damage.
 - Before installing or requiring any active drainage structure (e.g., drain pipe) into the foundation or pad, the contractor, CMP Line Supervisor, or CMP Distribution Engineer must contact Central Maine Power Company's Environmental Services Department at 623-3521 ext. 3479 to request a site inspection.
 - Finish grade shall be graded in such a manner to allow surface water to flow away from the pad.
 - Provide 8" X 24" cable holes (bond outs) 8' up the wall from the base. Locate one cable hole per wall, more if necessary. Line up cable holes with trench.
 - Conduits entering concrete structures shall be set back from the inside wall 1 to 2 inches and the space within the knockout surrounding the conduits completely filled with mortar to prevent soil from entering structure. Inside the structure the mortar shall be finished and beveled from the conduit ends to the inside wall face to cover and smooth the edges of the knockouts.
 - A 3/4" X 8" galvanized ground rod is to be installed six inches in front of the left FRONT corner of the foundation. The top of the ground rod is to be 6 inches below final grade.
 - A ground wire shall be installed from the ground rod through the cable hole at the bottom of the pad. 20 Feet of ground wire shall be provided so that it can be installed through the two grounding lugs and connected to the neutral spade.
 - Concrete compressive strength shall be 4000 PSI @ 28 days. For cast-in-place early high strength may be used with a minimum of seven day cure time.
 - Reinforcing steel to have: FY = 60 KSI.
 - The precast supplier shall provide lifting lugs in the slab (foundation) and base; the precast supplier shall assemble the slab to the base prior to shipping to the site to ensure that the slab and base fit properly (with no rocking of the slab evident).
- Use a 24" X 24" X 1/4" galvanized steel plate to cover a portion of the cable hole when the transformer does not completely cover it. Cut the steel plate to fit, if necessary.
 - 9-#5 Rebar evenly spaced each way top to bottom.
 - 2-#4 Corner diagonal rebar 2'-0" long top and bottom.
 - A 3/4" deep by 9" wide groove on the underside of the pad top shall be provided to keep the top in place.
 - Chamfer typical
 - 2" Concrete cover over top rebar.
 - 3" Concrete cover over bottom rebar.
 - 24" X 24" X 1/4" galvanized steel plate, MID#6000621795
 - #5 Rebar on 12" centers.
 - Pulling eye insert, for use with 3/4" national course thread eye-bolt, (Richmond LCB-1 or equivalent). Located opposite each cable hole and 2' (two feet) from the bottom.
 - All rebar ends to be covered by 1' of concrete, minimum.
 - For cast-in-place construction, see Distribution Engineer.

XII. Illustration No. 25 (continued)

364-10 / LARGE 9' X 9' THREE-PHASE TRANSFORMER FOUNDATION

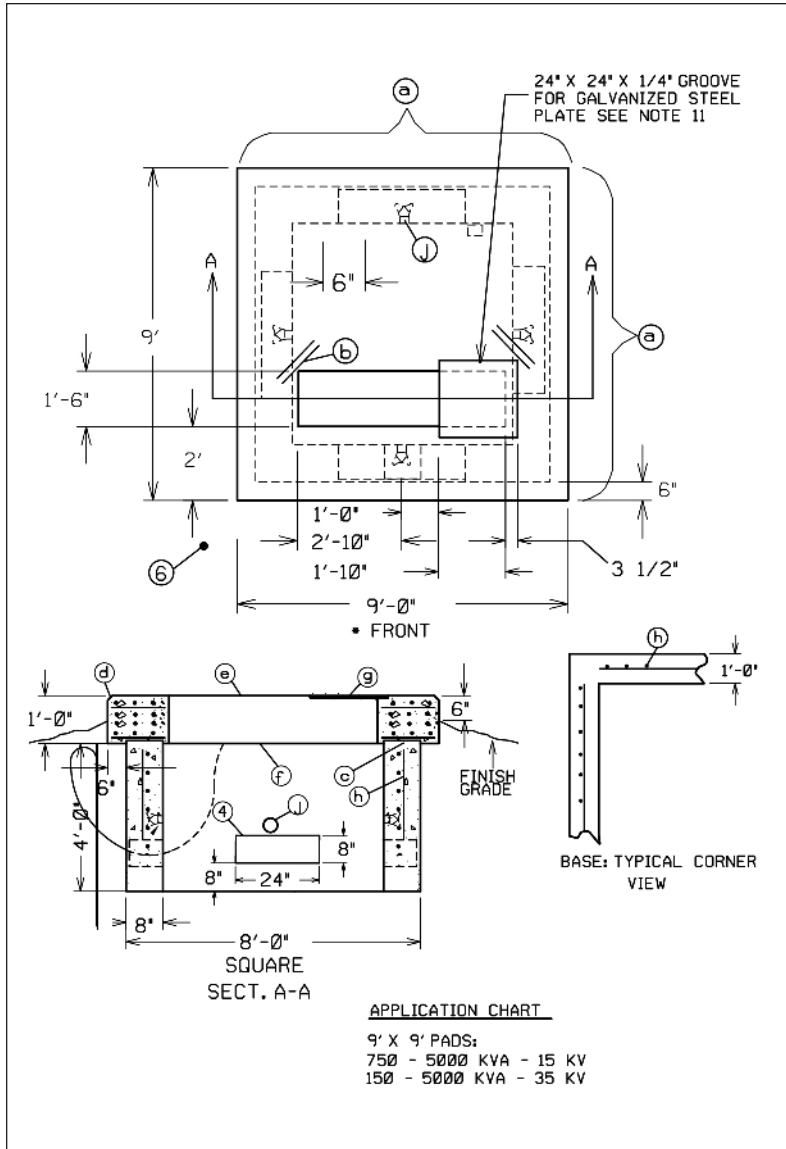

XII. Illustration No. 26

364-3 / FIBERGLASS BOX PAD

TRANSFORMER INSTALLATIONS

- The fiberglass 43" x 38" x 32" pad CU C6TDFB (MID*6000673961) is suitable for both 7.2/12.47kV and 20/34.5kv single phase transformer installations.
- FRONT denotes the side on which the access doors are located. The base shall be located so the FRONT is accessible by truck and suitably protected from plow and traffic damage.
- Before installing or requiring any active drainage structure (e.g., drain pipe) into the foundation or pad, the contractor, CMP Line Supervisor, or CMP Distribution Engineer must contact Central Maine Power Company's Environmental Services Department at 623-3521 ext. 3479 to request a site inspection.
- Finish grade shall be graded in such manner to allow surface water to flow away from the pad.
- A 3/4" X 8' galvanized ground rod is to be installed 6'in front of the left corner of the transformer foundation. The top of the ground rod shall be 6" below final grade.

PRIMARY JUNCTION BOX

- The fiberglass pad CU C6UDJ8FP (MID*6000673961) is suitable for both 7.2/12.47kV and 20/34.5kV single phase junction boxes.

- Use fiberglass flat cover CU C6UDJ8FCF (MID*6000673931), or JRD cabinet CU C6UDCUT1 (MID*6000621460) to cover the pad opening on single phase installations.

- Finish grade shall be graded in such manner to allow surface water to flow away from the pad.

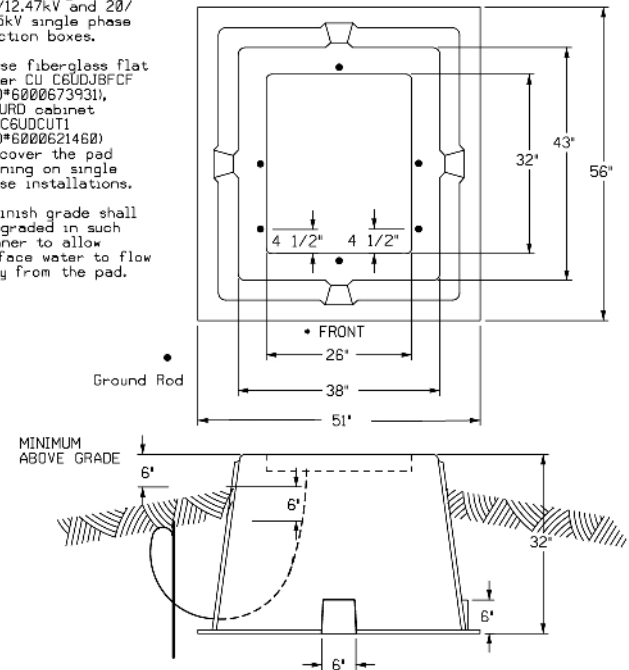

XII. Illustration No. 27

361 / PRIMARY CABLE CONDUIT/RISER SIZES

TABLE 1: Conduit Sizes for Jacketed Cable Minimum size required in inches.						
Cable Type	Cable Size	Number of Conductors				
		1	2	3	4	
15KV	URD	#2 Stranded	2 1/2"	3"	4"	5"
		4/0 XLP	2 1/2"	4"	5"	5"
	Power	500 KCM XLP	3"	5"	5"	6"
		750 KCM XLP	3"	5"	6"	6"
35KV	URD	1/0 XLP	2 1/2"	4"	5"	5"
		4/0 XLP	3"	5"	6"	6"
	Power	500 KCM XLP	3"	5"	*	*

* Contact local CMP Distribution Engineer

TABLE 2: Minimum wire sizes for connections between system neutral and urd cable neutral

CABLE SIZE	POLE NEUTRAL CU
#2	C6UDCU4TWAS
1/0	C6UDCU2TWAS
4/0	C6UDCU2/0TWAS
Larger Than 4/0	C6UDCU4/0TWAS

Notes:

1. Minimum clearance between top of pin terminal and primary conductor shall be 18" for 7.2KV and 21" for 19.9KV to allow grounding of cable
2. If all steel conduit, insulated ground bushing is required.
3. All cutouts on riser pole feeding urd cables shall be normally closed

XII. Illustration No. 28

361-3A / CONDUIT STANDOFF BRACKET FOR MULTIPLE RISERS ON ONE POLE

NOTES

1. Standoff brackets are required when more than one conduit per utility is to be installed on a pole.
2. All three phase primary risers, whether stand off brackets are used or not, shall be rigid steel for the first section.
3. On single phase primary, secondary and service URD risers using stand off brackets, rigid steel or schedule 80 may be used.
4. Where rigid steel or schedule 80 PVC is used for the riser, one bracket shall be used to support each section of conduit up to 10 feet in length. Each bracket is to be placed just below the riser conduit coupling.
5. Conduit sections for single phase or three phase risers using stand off brackets shall be rigid steel or schedule 80 PVC conduit only (See note #2), with the exception that schedule 40 PVC sunlight resistant conduit may be used for the top section of the riser (not longer than 10'). If top section is longer than 24' it must be supported with a minimum of one stand off bracket. If top section is schedule 40 PVC and longer than 72' it must be supported by no fewer than two stand off brackets.
6. Where PVC is used for the riser, each stand off bracket supporting the PVC shall be grounded. Where steel is used for the riser one stand off bracket supporting the steel is required to be grounded.
7. Sweeps, when used, are required to be steel.
8. If riser is all steel conduit, install insulated grounding bushing at top of riser.
9. Lowest bracket shall be a minimum of 8 feet above finished grade.
10. Alternate location for communication cable if run in metal conduit or schedule 80.
11. Communication cable may be attached directly to pole adjacent to brackets.

XII. Illustration No. 28 (continued)

361-3B / CONDUIT STANDOFF BRACKET FOR MULTIPLE RISERS ON ONE POLE

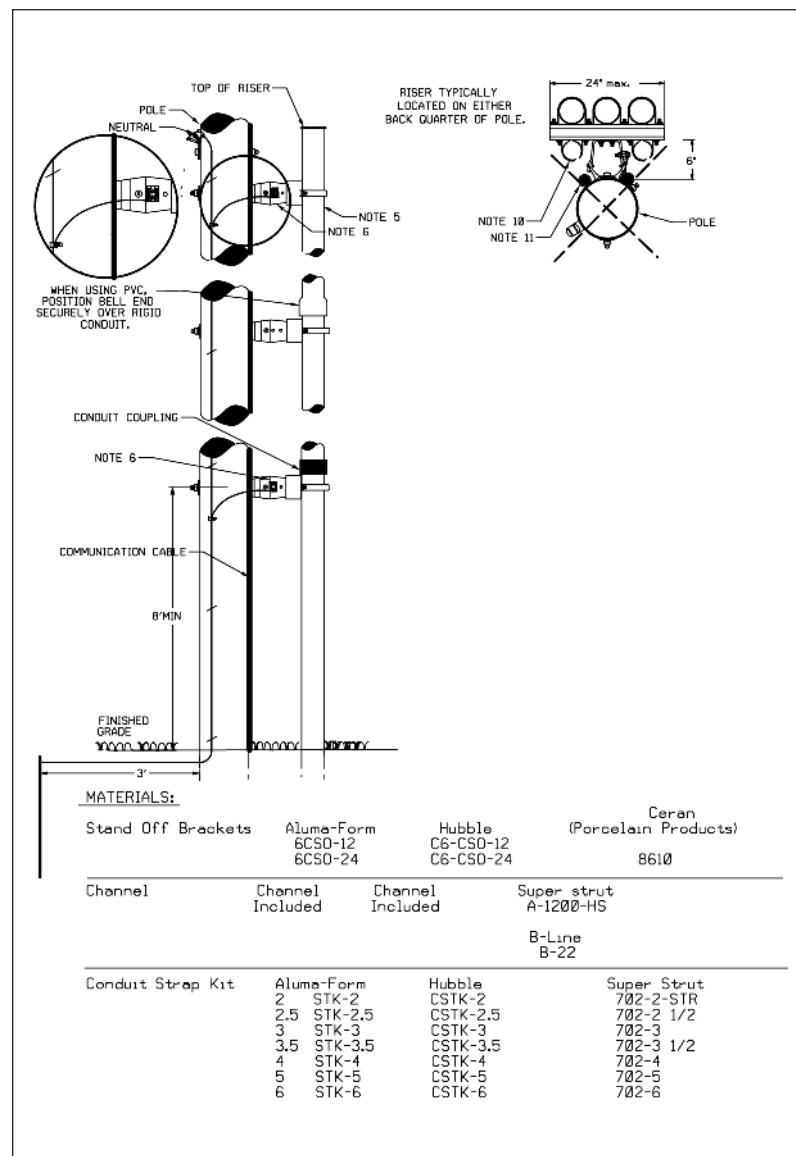

XII. Illustration No. 29

361-2A / PRIMARY URD RISER SINGLE CONDUIT

1. Seal top of conduit with polyurethane sealer. Top of conduit must extend 4' above the neutral. If all steel, top of conduit must have an insulated grounding bushing.

2. If top section of riser is less than 5 feet in length, it must be supported with at least one steel U clip with 5/16th inch holes. If top section of riser is PVC and greater than 5 feet in length, it must be supported with no less than two steel U clips with 5/16th inch holes.

3. Coupling of same material as upper conduit is not required if using conduit with belled end installed down over lower conduit.

4. If steel conduit, a conduit ground connector made of either copper alloy or galvanized steel material of suitable design shall be used. Install pole ground if one doesn't exist.

5. Two hole steel U clips with 5/16th holes are required at top and middle of each section of PVC conduit that is over 60 inches in length. If the riser is all steel, two hole U clips with 5/16th inch holes are required at the bottom and top of first section and at the top of each section, there after. The steel U clips shall be secured to the pole with 5/16th X 3 inch lag screws.

**Bottom Section: (2) clips if steel conduit,
(3) clips if schedule 80 pvc conduit**

**Middle Section: (1) clip if steel conduit,
(2) clips if pvc conduit**

**Top Section: (1) clip if steel conduit,
(1) clip if pvc conduit less than 5ft.,
(2) clips if pvc conduit greater than 5ft.**

6. Rigid steel, steel IMC, Schedule 80 PVC, or Schedule 40 PVC rated for outdoor use may be used on riser. However first section of riser shall be rigid steel or schedule 80 PVC. All three phase primary risers shall be rigid steel for the first section.

7. Use threaded/non-threaded coupling or insulated bushing at the bottom of riser.

8. Standoff brackets will be required where future customers are likely to be served from the same pole.

XII. Illustration No. 29 (continued)

361-2B / PRIMARY URD RISER SINGLE CONDUIT

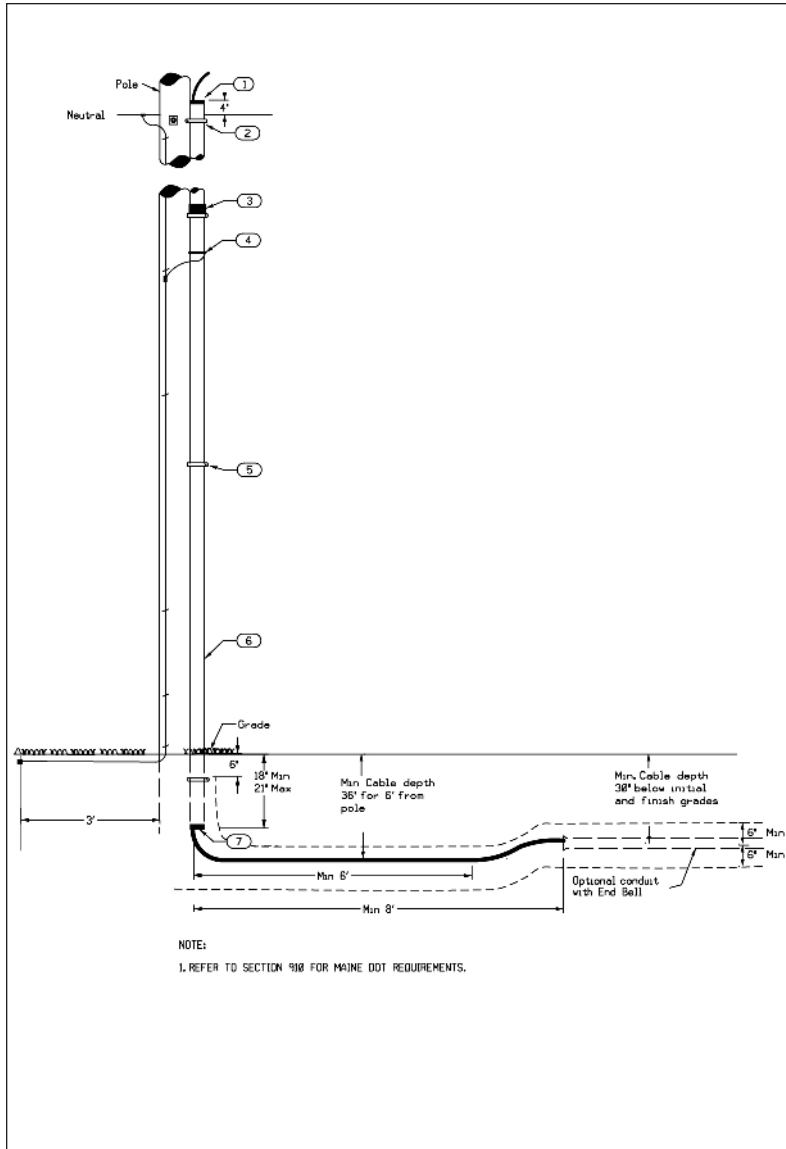

XII. Illustration No. 30

361-1A / SECONDARY OR SERVICE URD RISER SINGLE CONDUIT

1. Seal top of conduit with polyurethane sealer. Top of conduit must extend 4" above the neutral. If all steel, top of conduit must have an insulated grounding bushing.

2. If top section of riser is less than 5 feet in length, it must be supported with at least one steel U clip with 5/16th inch holes. If top section of riser is PVC and greater than 5 feet in length, it must be supported with no less than two steel U clips with 5/16th inch holes.

3. Coupling of same material as upper conduit is not required if using conduit with belled end installed down over lower conduit.

4. If steel conduit, a conduit ground connector made of either copper alloy or galvanized steel material of suitable design shall be used. Install pole ground if one doesn't exist.

5. Two hole steel U clips with 5/16" holes are required at top and middle of each section of PVC conduit that is over 60 inches in length. If the riser is all steel, two hole U clips with 5/16th inch holes are required at the bottom and top of first section and at the top of each section, there after. The steel U clips shall be secured to the pole with 5/16th X 3 inch lag screws.

Bottom Section: (2) clips if steel conduit,

(3) clips if schedule 80 pvc conduit

Middle Section: (1) clip if steel conduit,

(2) clips if pvc conduit

Top Section: (1) clip if steel conduit,

(1) clip if pvc conduit less than 5ft.,

(2) clips if pvc conduit greater than 5ft.

6. Rigid steel, steel IMC, Schedule 80 PVC, or Schedule 40 PVC rated for outdoor use may be used on riser. However first section of riser shall be rigid steel or schedule 80 PVC.

7. Use threaded/non-threaded coupling or insulated bushing at the bottom of riser.

8. Standoff brackets will be required where future customers are likely to be served from the same pole.

XII. Illustration No. 30 (continued)

361-1B / SECONDARY OR SERVICE URD RISER SINGLE CONDUIT

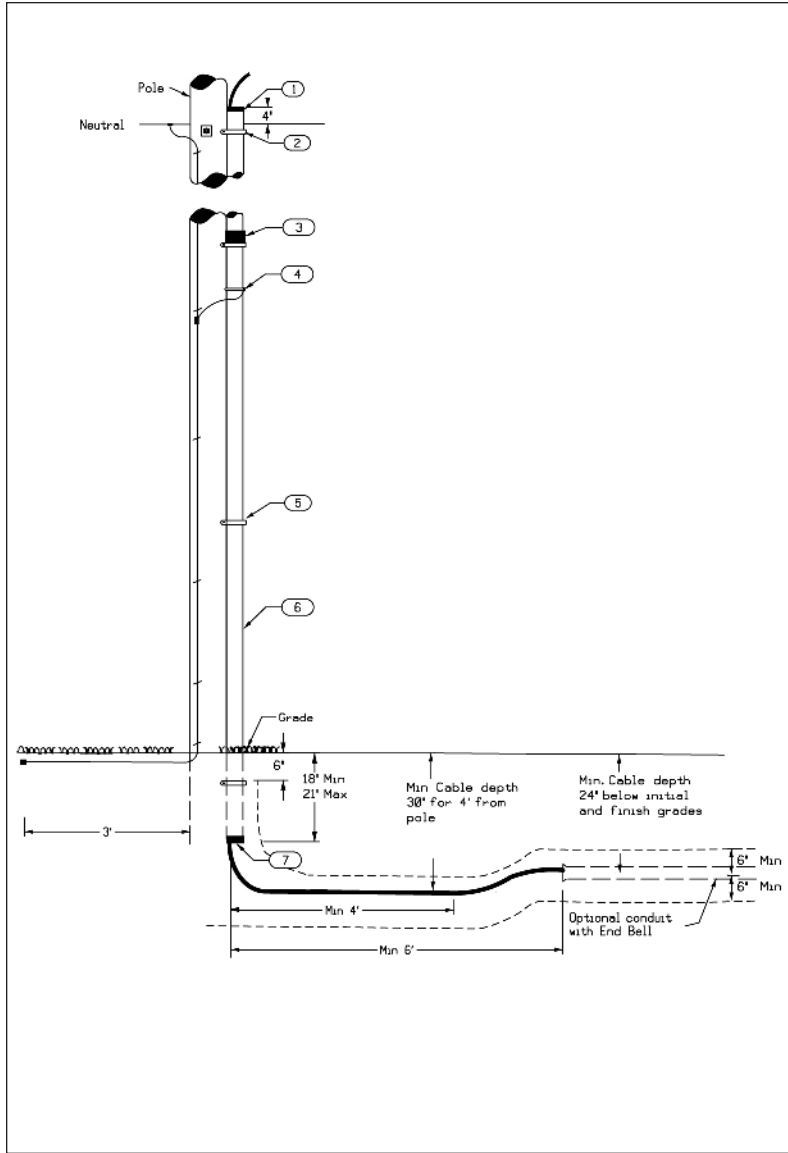

XII. Illustration No. 31

980-31.6 / ALLOWABLE SECONDARY AND SERVICE LENGTH

ALLOWABLE SECONDARY AND SERVICE LENGTHS IN FEET FOR VARIOUS **CUSTOMER OWNED RESIDENTIAL** SERVICE SIZES AND CONDUCTOR TYPES
 (120/240 VOLT, SINGLE-PHASE, 3-WIRE SERVICE)

Conductor Size	100 Amp Service		150 Amp Service		200 Amp Service		400 Amp Service	
	Aluminum	Copper	Aluminum	Copper	Aluminum	Copper	Aluminum	Copper
#2	135	--	na	--	na	--	na	--
1/0	210	--	140	--	na	--	na	--
4/0	430	--	290	--	215	--	na	--
336.4	630	--	420	--	315	--	75'	200'

OVERHEAD CONDUCTORS

Conductor Size	100 Amp Service		150 Amp Service		200 Amp Service		400 Amp Service	
	Aluminum	Copper	Aluminum	Copper	Aluminum	Copper	Aluminum	Copper
#2	150	215	na	195	na	na	na	na
1/0	190	290	na	235	na	na	na	na
2/0	235	350	na	290	na	215	na	na
3/0	295	435	195	290	na	265	na	na
4/0	440	650	240	355	na	325	na	na
250	500	725	295	435	220	325	na	na
350	600	875	340	485	250	360	na	na
500	850	1150	440	605	330	455	na	na
2 - 4/0	885	1300	580	765	435	575	na	290
2 - 250	1015	1450	675	865	440	650	na	325
2 - 350	1320	1835	885	1225	505	725	255	365
					660	915	330	460

UNDERGROUND CONDUCTORS

Notes:

- 1 - "na" indicates conductor not adequate for the load/service. Refer to NEC Table 310.17 @75°C for overhead conductors; Refer to NEC Table 310.16 for underground conductors.
- 2 - Calculations are based on 80% loading of service and 3% voltage drop.
- 3 - Distances are total circuit feet from service transformer terminals to customer's service entrance panel.
- 4 - Some conductors may require oversized, or special ordered meter enclosure with 3/8" stud type connections.
- 5 - Overhead secondary conductors run pole to pole are subject to all requirements of the customer owned line extension policy.
- 6 - See Handbook paragraph 985 for CNP Standard underground service sizes and lengths.
- 7 - Refer to Section 985 for splice requirements.
- 8 - 400 amp services shall be installed underground.

XII. Illustration No. 32

980-31.3.4 / UNDERGROUND SERVICE CUSTOMER OWNED TYPE MC CABLE

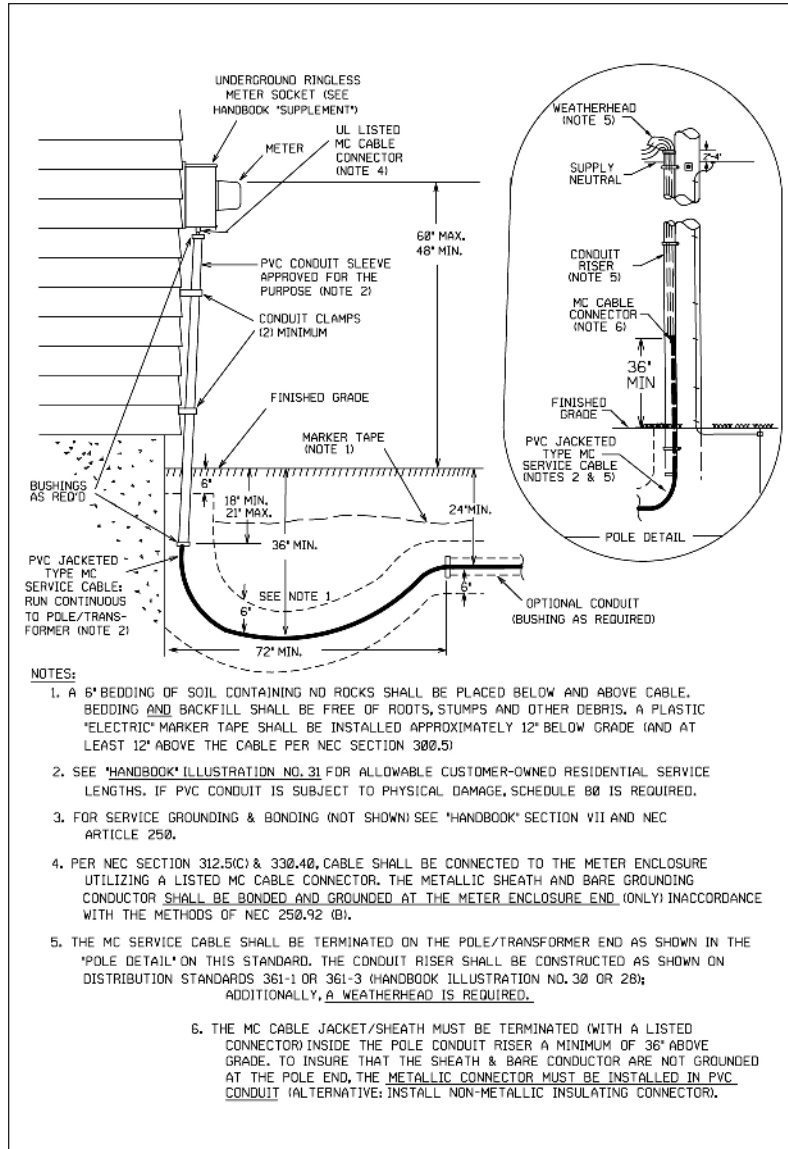

XII. Illustration No. 33

905A-6 / HEAVY DUTY 4' X 6' JUNCTION BOX FOR PRIMARY INSTALLATIONS

